

Numéro gratuit : 0805 691 217

MOBILIER MANUFACTURÉ ET SUR MESURE

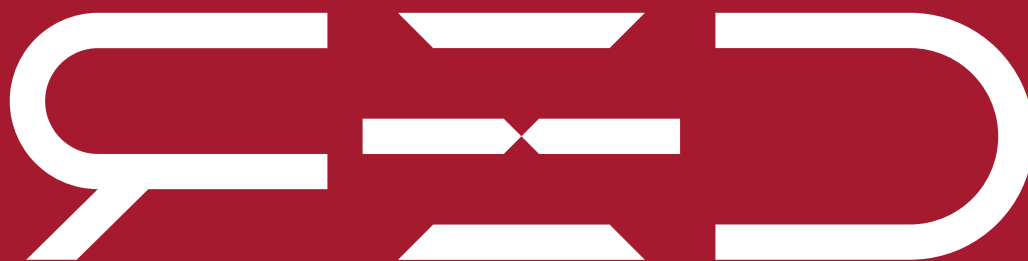

EXCLUSIVE DESIGN

R.E.D FRANCE

45 rue Delizy 93500 Pantin.
contact@redexclusivedesign.fr

R.E.D Italia

Produzione Metallica:
C.da Rotondo, 10 - 62029 - Tolentino (MC)
Sede Logistica:
Via I Maggio, 3H - 62100 - Macerata (MC)
Produzione Legno:
Via Don Ezio Cingolani, 4 - 62010 - Montecassiano (MC)

CATALOGUE 2025

Index

RED Exclusive Design:

PHILOSOPHY 2

Direzionali

GHOST 8

DHOW 28

EXE NOX 48

Semidirezionali

EXE WOOD 66

MATeRIAL 88

SQUARE/PRESTIGE 112

Operativi

SCAB 132

K2 152

lorC 170

Reception

MAGIC 188

Contenitori

ARMADI 222

CASSETTIERE 230

MOBILI DI SERVIZIO 240

RED Exclusive Design: il vostro partner di fiducia

Fondata nel 2013, RED si contraddistingue da subito per la sua dinamicità che le permette di evolversi e specializzarsi nella produzione di arredi per ufficio, divenendo ben presto una realtà all'avanguardia in grado di offrire una risposta fortemente competitiva alle richieste del mercato.

La predisposizione a crescere ed innovare ci ha portato ad espandere le soluzioni progettuali proponendo una modularità sempre più ampia, nonché una vasta proposta di finiture che permettono la **massima personalizzazione dell'ambiente ufficio**.

La disponibilità in **pronta consegna** degli articoli più venduti, garantisce una spedizione e un allestimento rapido in ogni parte d'Italia.

Grazie al servizio di **progettazione e realizzazione di arredi custom**, ascoltiamo le persone e progettiamo secondo le loro esigenze, garantendo tempi e costi certi.

La filiera produttiva, scelta accuratamente, ci permette di proporci come **unico partner per l'arredo di spazi commerciali, bancari, uffici e hotellerie**, con soluzioni attuali che garantiscono qualità al giusto prezzo.

RED: votre partenaire de confiance

Fondée en 2013, RED se distingue dès ses débuts par son dynamisme qui lui permet d'évoluer et de se spécialiser dans la production de mobilier de bureau. Elle devient rapidement une réalité à l'avant-garde, apte à répondre de façon compétitive à la demande du marché.

Notre propension à vouloir grandir et à innover, nous amène à développer des solutions conceptuelles proposant une modularité toujours plus importante ainsi qu'une vaste gamme de finitions afin de **personnaliser le plus possible l'espace bureau**.

La disponibilité des articles les plus vendus en **livraison express** garantit une expédition et une installation rapides sur tout le territoire.

Grâce à notre service de **conception et réalisation de meubles sur mesure** à l'écoute des personnes, nous élaborons des projets selon leurs exigences tout en garantissant les délais et les coûts.

La filière de production, choisie avec soin, nous permet de nous proposer comme **partenaire unique pour l'aménagement d'espaces commerciaux et bancaires, de bureaux et d'hôtellerie**, avec des solutions actuelles qui garantissent la qualité à un juste prix.

RED: your trusted partner

Founded in 2013, RED has immediately stood out for its dynamism that allowed the company to evolve and specialize in manufacturing of office furniture, becoming soon an avant-garde reality capable of offering a highly competitive answer to market demand.

The predisposition to grow and innovate has led us to expand the design solutions by offering an ever wider modularity, as well as a wide range of finishes that allow the **greatest customization of the office environment**.

The **ready-to-delivery** availability of the best-selling items guarantees a quick shipping and a set-up worldwide.

Thanks to the **design and manufacture of the custom furniture**, we listen to people and we design according to their needs by guaranteeing certain times and costs.

The carefully chosen production chain allows us to offer ourselves as the **only partner for the furnishing of commercial, banking and office spaces and hotels**, with modern solutions that guarantee the quality at the right price.

RED: su socio de confianza

Fundada en 2013, RED se destaca de inmediato por su dinamismo que le permite evolucionar e especializarse en la fabricación de mobiliario de oficina, convirtiéndose pronto en una realidad de vanguardia capaz de ofrecer una respuesta altamente competitiva a las demandas del mercado.

La predisposición a crecer e innovar nos ha llevado a ampliar las soluciones de diseño ofreciendo una modularidad cada vez más amplia, así como una amplia gama de acabados que permiten la **máxima personalización del entorno de oficina**.

La disponibilidad de **entrega inmediata** de los artículos más vendidos garantiza un envío y una configuración rápidos en cualquier parte.

Gracias al **diseño y a la fabricación de muebles a medida**, escuchamos a las personas y diseñamos de acuerdo a sus necesidades, garantizando ciertos tiempos y costos.

La cadena de producción, cuidadosamente elegida, nos permite proponernos como el **único socio para el equipamiento de espacios comerciales, bancarios y de oficinas**. Y hoteles, con soluciones actuales que garantizan calidad al precio justo.



Qualità certificata 100% Made in Italy

La qualità è per noi un fattore chiave alla base di ogni lavorazione: dalla selezione accurata dei materiali, alla realizzazione. Per offrirvi prestazioni eccellenti e durata nel tempo. Una qualità certificata periodicamente dai più importanti laboratori.



CVI QUALITY SYSTEM CERTIFICATE

Code of the certification body: **1-421-001-015**
Number of the certificate: **6218**

This is to certify that
the Quality Management System of
SP OFFICE S.R.L.
VIA 1 MAGGIO 3H - 62100 MACERATA (MC)
is in compliance with the Quality Management System Standard
ISO 9001:2015

This Certificate is applicable to the following activities:

OFFICE FURNITURE PRODUCTION

System certified from 10/06/2015	Current issue on 10/06/2021	Expiry date 10/06/2024
--	---------------------------------------	----------------------------------

subject to passing two surveillance audits during 6-12 months and 18-24 months of the certification.





Ing. Jan Gasper
CVI, s.r.o. director

Certification is granted by: CVI, s.r.o., MPCL 3170/31, 058 01 Poprad. For precise and up-to-date information on possible changes in the status of the certification referred to in this certificate, please phone to the number: **+421 944 013365** or e-mail to the address: **info@cvl.sk** or contact **CVI ITALIA SRLS**, Via Dell'Arcoveggio, 48/A, 40129 - Bologna, Phone: **+39 800 198 099**, Email: **info@cvl-italia.com**

CONFORMANCE VERIFICATION INTERNATIONAL



CVI CERTIFICATO SISTEMA DI GESTIONE AMBIENTALE

Code dell'organismo di certificazione: **1-421-001-025**
Certificato N°: **6219**

Si attesta che il Sistema di Gestione Ambientale di
SP OFFICE S.R.L.
VIA 1 MAGGIO 3H - 62100 MACERATA (MC)
È conforme ai requisiti della normativa
ISO 14001:2015

Questa certificazione è valida per il seguente campo di applicazione:

PRODUZIONE MOBILI PER UFFICIO

Sistema certificato da: 10/06/2015	Emissione Corrente: 10/06/2021	Data di Scadenza: 10/06/2024
--	--	--

subordinata al superamento di due audits di sorveglianza nei 6-12 mesi e 18-24 mesi successivi alla data di certificazione.





Ing. Jan Gasper
Direttore CVI, s.r.o.

La Certificazione è rilasciata da: CVI, s.r.o., MPCL 3170/31, 058 01 Poprad. Per informazioni puntuali e aggiornate circa eventuali variazioni intervenute nello stato della certificazione di cui al presente certificato, si prega di contattare il n° telefonico: **+421 944 013365** o indirizzo mail: **info@cvl.sk** o contattare **CVI ITALIA SRLS**, Via Dell'Arcoveggio, 48/A, 40129 - Bologna, Tel.: **+39 800 198 099**, Email: **info@cvl-italia.com**

CONFORMANCE VERIFICATION INTERNATIONAL

Certificazioni ISO 9001



Attestano l'attenzione nella gestione della produzione, per garantire la qualità durante tutto il percorso che va dalla definizione dei bisogni del cliente fino alla loro soddisfazione, attraverso la gestione di tutte le diverse attività aziendali.

Qualité 100% Italienne Certifiée

La qualité représente pour nous un facteur clé à la base de tout travail, de la sélection scrupuleuse des matériaux à la réalisation, afin de vous offrir d'excellentes prestations et durabilité. Une qualité qui est périodiquement certifiée par les laboratoires les plus importants.

Certifications ISO 9001 - Elles attestent de l'attention portée dans le management de la production, afin de garantir la qualité tout au long du parcours allant de la définition des besoins à la satisfaction du client à travers la gestion de l'ensemble des activités de l'entreprise.

Certifications ISO 14001 - Elle atteste de l'attention et du respect de l'environnement, du développement d'un Système de Management Environnemental efficace, afin d'améliorer toutes les activités de l'entreprise pouvant avoir un impact sur l'environnement.

Certifications ISO 45001:2018 - Nous pensons que le respect de la santé de la personne part de l'intérieur, de ceux qui, grâce à leur professionnalisme, réalisent des produits de qualité. C'est pour cette raison que SP Office a demandé la certification relative à la sécurité et à la qualité du travail.

Certificazione ISO 14001



Attesta l'attenzione e il rispetto dell'ambiente, lo sviluppo di un efficace Sistema di Gestione Ambientale, al fine di migliorare tutte le attività aziendali che possono avere un impatto sull'ambiente.

Quality 100% Italian Certified

Quality is for us a key factor at the base of every process: from the careful selection of materials to the realization. To offer you excellent performance and durability. A quality certified periodically by the most important laboratories.

Certifications ISO 9001 - They certify the attention paid to the management of the production, to ensure quality throughout the process that goes from the definition of the customer's needs to their satisfaction, through the management of all the different company activities.

Certifications ISO 14001 - It certifies the attention to the environment and the respect for it, the development of an effective Environmental Management System, in order to improve all business activities that may have an impact on the environment.

Certifications ISO 45001:2018 - We believe that the respect of the human health starts right from within, from those who, through their professionalism, create quality products. That is the reason why SP Office has requested the safety and quality of work certification.

Certificazione ISO 45001:2018



Crediamo che il rispetto della salute dell'uomo parta proprio dall'interno, da coloro che attraverso la loro professionalità realizzano prodotti di qualità. Ecco perché RED ha richiesto la certificazione di sicurezza e qualità del lavoro.

Calidad 100% italiano Certificado

Para nosotros, la calidad es un factor clave detrás de cada proceso: desde la cuidadosa selección de materiales hasta la implementación. Para ofrecerle un excelente rendimiento y durabilidad. Una calidad certificada periódicamente por los laboratorios más importantes.

Certificaciones ISO 9001 - Certifican la atención prestada a la gestión de la producción, para asegurar la calidad en todo el proceso que va desde la definición de las necesidades del cliente hasta su satisfacción, pasando por la gestión de todas las diferentes actividades de la empresa.

Certificaciones ISO 14001 - Certifica la atención y el respeto al medio ambiente, el desarrollo de un Sistema de Gestión Ambiental eficaz, con el fin de mejorar todas las actividades de la empresa que puedan tener un impacto en el medio ambiente.

Certificaciones ISO 45001:2018 - Creemos que el respeto de la salud humana comienza desde dentro, desde aquellos que a través de su profesionalismo crean productos de calidad. Es por eso que SP Office solicitó la certificación de seguridad y calidad del trabajo.

Rispetto per l'ambiente e per l'uomo

Il rispetto per le risorse ambientali e il benessere dell'uomo sono al centro di ogni nostro progetto. Ecco perché realizziamo i nostri arredi utilizzando pannelli ecologici riciclati, vernici prive di metalli pesanti e legni provenienti da foreste certificate, assicurando la massima riduzione delle emissioni tossiche e l'eliminazione dei composti nocivi come la formaldeide.



Pannelli ecologici riciclati al 100%

Utilizziamo solo i migliori pannelli ecologici certificati, realizzati in Italia con legno riciclato post-consumo; che presentano ottime caratteristiche di idrorepellenza e basse emissioni di formaldeide.

Le respect de l'homme et de l'environnement

Le respect des ressources environnementales et le bien-être de la personne sont au centre de tous nos projets. Pour cette raison, nous réalisons nos meubles en utilisant des panneaux écologiques recyclés, des vernis sans métaux lourds et des bois issus de forêts certifiées, garantissant la plus grande réduction d'émissions de substances toxiques et l'élimination de composés nocifs tels que le formaldéhyde.

Laquages avec des vernis à l'eau

Nos laquages sont réalisés avec des vernis à l'eau alliant l'innovation et la haute qualité au plus grand respect de l'environnement.

Des panneaux écologiques recyclés à 100%

Nous utilisons uniquement les meilleurs panneaux écologiques certifiés, réalisés en Italie avec du bois usagé recyclé. Ils présentent d'excellentes caractéristiques hydrofuges et de faibles émissions de formaldéhyde.

Une optique durable anti-gaspillage

Chaque meuble est conçu dans une optique durable anti-gaspillage et est produit selon des procédés à faible impact environnemental. Les matériaux utilisés, tels que le verre et l'acier inoxydable, sont eux aussi écologiques et recyclables.

Laccature con vernici all'acqua

Le nostre laccature sono realizzate con vernici all'acqua che coniugano innovazione, altissima qualità e massimo rispetto per l'ambiente.

Respect for the environment and for the man

The respect for environmental resources and the human well-being are at the heart of all our projects. That's why we make our furniture using recycled ecological panels, heavy metal-free paints and woods from certified forests, ensuring the maximum reduction of toxic emissions and the elimination of harmful compounds such as formaldehyde.

Lacquering with water-based paints

Our lacquers are made with water-based paints that combine innovation, high quality and maximum respect for the environment.

100% recycled ecological panels.

We only use the best certified ecological panels, made in Italy with post-consumer recycled wood; which have excellent water-repellent characteristics and low formaldehyde emissions.

Sustainable zero-waste approach

Each piece of furniture is designed in a sustainable zero-waste approach and produced with methods with low environmental impact. Materials such as glass and stainless steel are ecological and recyclable too.

Ottica sostenibile anti-spreco

Ogni arredo è pensato in un'ottica sostenibile anti spreco e prodotto con metodi a basso impatto ambientale. Ecologici e riciclabili anche i materiali come il vetro e l'acciaio inox.

El respeto por el medio ambiente y por el hombre

El respeto por los recursos medioambientales y el bienestar humano están en el centro de todos nuestros proyectos. Por eso fabricamos nuestros muebles con paneles ecológicos reciclados, pinturas libres de metales pesados y maderas de bosques certificados, asegurando la máxima reducción de emisiones tóxicas y la eliminación de compuestos nocivos como el formaldéhid.

Lacado con pinturas al agua

Nuestros lacados están elaborados con pinturas al agua que combinan innovación, alta calidad y máximo respeto por el medio ambiente.

Paneles ecológicos 100% reciclados

Solo utilizamos los mejores paneles ecológicos certificados, fabricados en Italia con madera reciclada post consumo; que tienen excelentes características repelentes al agua y bajas emisiones de formaldéhid.

Marco sostenible antidesgaste

Cada mueble está diseñado en una perspectiva sostenible antidesgaste y producida con métodos de bajo impacto ambiental. Materiales como vidrio y acero inoxidable son también ecológicos y reciclables.



Caratteristiche:

- Struttura con gambe a sezione triangolare in acciaio cromato o verniciato in 3 finiture.
- Piani in nobilitato disponibili in 9 finiture.
- Piani in cristallo disponibili in 2 finiture.
- Piani rivestiti in Fenix disponibili in 5 finiture.
- Mobili di servizio per composizioni in appoggio.
- Personalizzazione infinita dei piani di lavoro.

Caractéristiques:

- Structure avec pieds à section triangulaire en acier chromé ou vernis en 3 finitions.
- Plateaux anoblis disponibles en 9 finitions.
- Plateaux en cristal disponibles en 2 finitions.
- Plateaux revêtus de Fenix disponibles en 5 finitions.
- Meubles de service porteurs pour les compositions.
- Infinité de possibilités pour personnaliser les plans de travail.

Features:

- Structure with triangular section legs in chromed or painted steel in 3 finishes.
- Melamine tops available in 9 finishes.
- Glass tops available in 2 finishes.
- Tops covered in Fenix available in 5 finishes.
- Service furniture for support compositions.
- Infinite customization of working surfaces.

GHOST

**Características:**

- Estructura con patas de sección triangular en acero cromado o pintado en 3 acabados.
- Encimeras de melamina disponibles en 9 acabados.
- Encimeras de cristal disponibles en 2 acabados.
- Encimeras revestidas en Fenix disponibles en 5 acabados.
- Mobiliario de servicio para composiciones de soporte.
- Personalización infinita de planus de trabajo.



GHOST 01





Il piano in vetro retro laccato si abbina perfettamente alla brillantezza della struttura cromata: materiali di pregio per un ufficio direzionale moderno ed elegante.

Le plateau en verre laqué se marie parfaitement au brillant de la structure chromée : des matériaux prestigieux pour un bureau de direction moderne et élégant.

The back-lacquered glass top perfectly matches the brilliance of the chromed structure: quality materials for a modern and elegant executive office.

La encimera de vidrio lacado al revés combina a la perfección con el brillo de la estructura cromada: materiales de calidad para una oficina ejecutiva moderna y elegante.



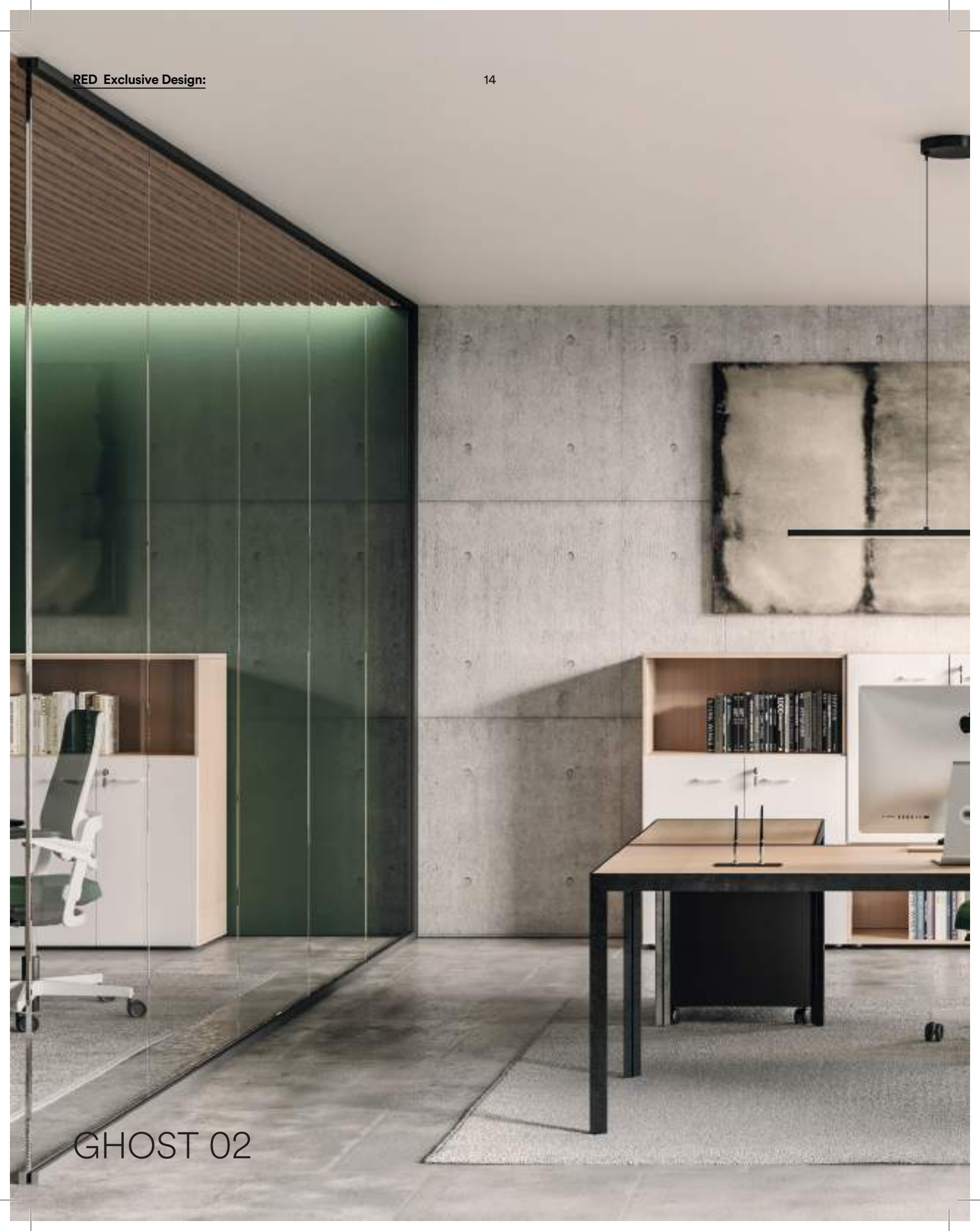

GHOST 02





La scrivania con allungo laterale permette di ottenere un piano supplementare, coniugando funzionalità e design.

Le bureau avec retour permet d'obtenir un plan de travail supplémentaire, alliant fonctionnalité et design.

The desk with lateral extension allows to obtain an additional top, combining functionality and design.

El escritorio con extensión lateral permite obtener un tablero adicional, combinando funcionalidad y diseño.









GHOST 03







L'isola di lavoro bench a 6 postazioni accessoriata con schermi divisorii, permette di condividere gli spazi e garantire la concentrazione in ufficio.

Les bureaux bench en îlot pour 6 personnes, équipés d'écrans de séparation, permettent de partager les espaces et de garantir la concentration au travail.

The bench working island with 6 workstations, equipped with dividing screens, allows you to share spaces and ensure concentration in the office.
La isla de trabajo bench con 6 puestos de trabajo, equipada con mamparas divisorias, permite compartir espacios y garantizar la concentración en la oficina.

Finiture / Finitions / Finishings / Acabados

STRUTTURA / STRUCTURE / FRAME / ESTRUCTURA



AL _Alluminio

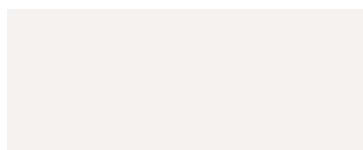

BI _Bianco

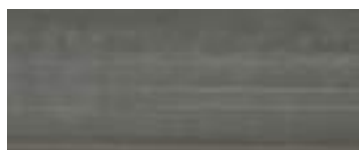

FE _Ferro



CR _Cromo

MELAMINICO LEGNO / MÉLAMINÉ DÉCOR BOIS / MELAMINE WOOD / MADERA MELAMINA



NC _Noce Canaletto



RS _Rovere Sbiancato



RG _Rovere Grigio



WE _Wengé



LA _Larice



OL _Olmo

MELAMINICO TINTA UNITA / MÉLAMINÉ TEINTE UNIE / PLAIN-COLORED MELAMINE / MELAMINA DE UN SOLO COLOR

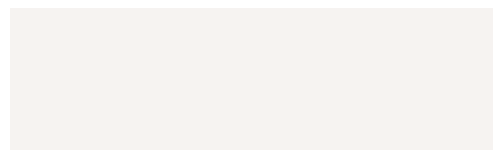

BI _Bianco



GR _Grigio



TO _Tortora

VETRI LACCATI / VERRES LAQUÉS / LACQUERED GLASS / VIDRIO LACADO

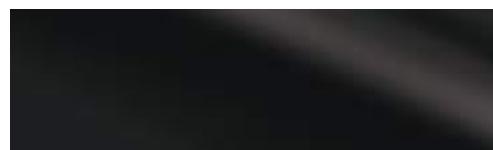

VNR _Vetro Nero



VBI _Vetro Bianco

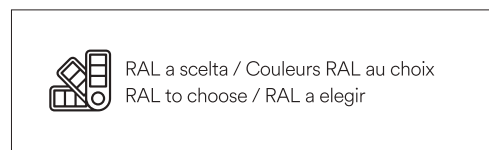

VSP _Vetro colore a scelta

FENIX

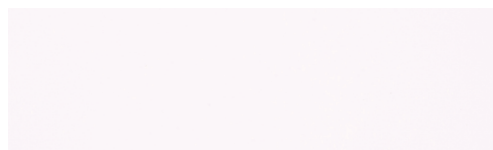

0030 _Bianco Alaska

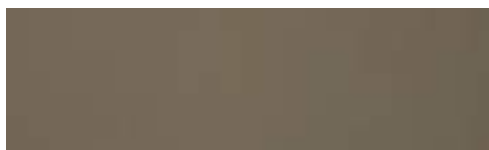

0717 _Castoro Ottawa



0720 _Nero Ingo



0724 _Grigio Bromo



0725 _Grigio Efeso

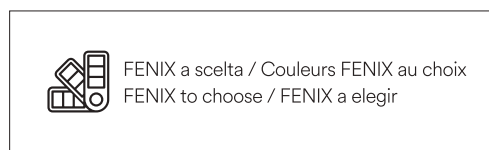

LACCATO LUCIDO E OPACO / LAQUÉ BRILLANT ET MAT / GLOSSY AND MATT LACQUER / LACADO

LAR _Arancio



LRS _Rosso



LBL _Blu



RAL a scelta / Couleurs RAL au choix
RAL to choose / RAL a elegir

TESSUTO / TISSU / TEXTURE / TEXTIL

TNR _Nero



TGR _Grigio



TBE _Beige



TBL _Blu



TCE _Celeste



TVE _Verde



TRS _Rosso



Tessuto a scelta / Tissu au choix
Texture to choose / Textil a elegir

Moduli / Modules / Modules / Modulos

SCRIVANIE / BUREAUX / DESKS / ESCRITORIOS

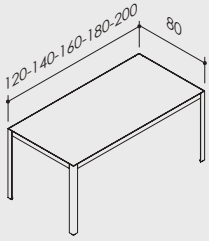

G10

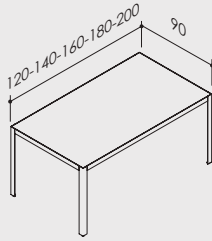

G12

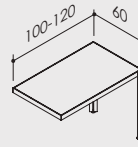

G20

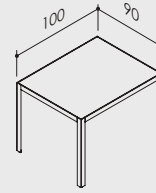

G27

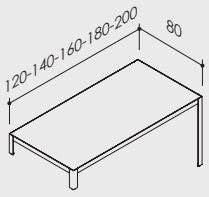

G10M

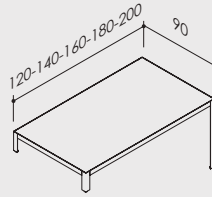

G12M

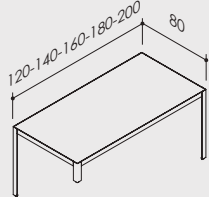

G10T

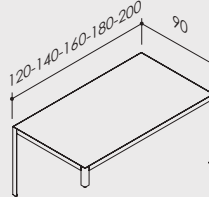

G12T

BENCH / BUREAUX BENCH / BENCH / BENCH

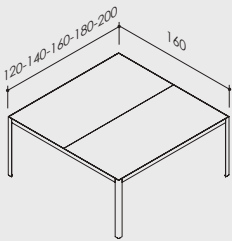

G60

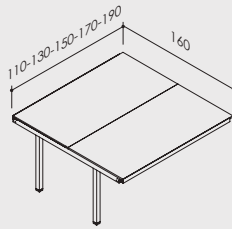

G65

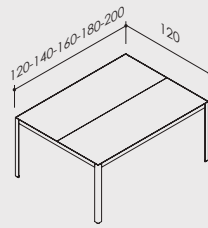

G50

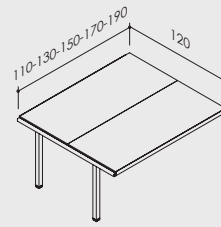

G55

TAVOLI RIUNIONE / TABLES DE RÉUNION / MEETING TABLES / MESAS DE REUNIONES

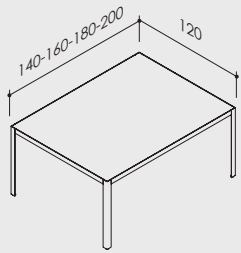

G41

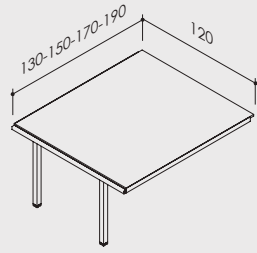

G42

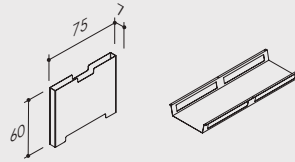

G17

A02

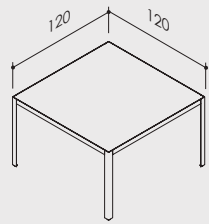

G43 120

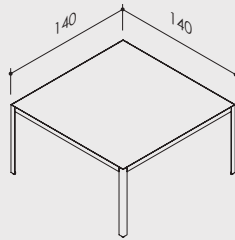

G43 140

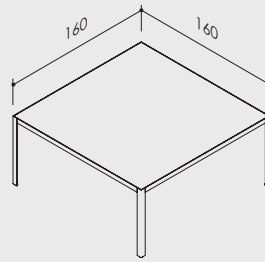

G43 160

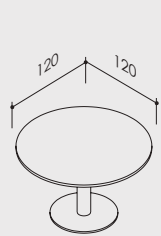

X11 120

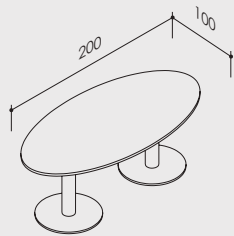

X12 200

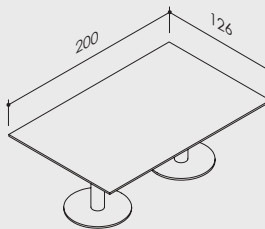

X10 200

TAVOLINI / TABLES BASSES / TABLES / MESAS

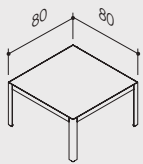

G45 080

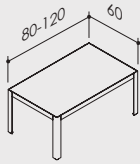

G46



Caratteristiche:

- Struttura in estruso di Alluminio.
- Piani in essenza disponibili in 5 finiture.
- Piani in cristallo disponibili in 4 finiture.
- Paratie in cuoio od in essenza con staffe in acciaio inox.

Caractéristiques:

- Structure en aluminium extrudé.
- Plateaux en essence de bois disponibles en 5 finitions.
- Plateaux en cristal disponibles en 4 finitions.
- Cloisons en cuir ou en essence de bois avec accessoires de fixation en acier inoxydable.

Features:

- Structure in extruded aluminum.
- Wood tops available in 5 finishes.
- Crystal tops available in 4 finishes.
- Bulkheads in leather or wood with brackets in stainless steel.

DHOW

**Características:**

- Estructura en extrusión de aluminio.
- Encimeras en madera disponibles en 5 acabados.
- Encimeras en cristal disponibles en 4 acabados.
- Mamparos en cuero o madera con escuadras en acero inoxidable.



DHOW 01





Gamba in alluminio e piano in vetro: gli spessori si alleggeriscono, i materiali diventano più tecnici e ricercati. Ne risulta un abbinamento modernissimo.

Avec les pieds en aluminium et le plateau en verre, les épaisseurs s'allègent et les matériaux deviennent plus techniques et recherchés. Il en résulte une combinaison très moderne.

Aluminum leg and glass top: the thicknesses are lighter, the materials become more technical and sophisticated. The result is a very modern combination.

Pata de aluminio y encimera en cristal: los espesores son más ligeros, los materiales se vuelven más técnicos y sofisticados. El resultado es una combinación muy moderna.





DHOW 02





Soluzione angolare con piano impiallacciato. DHOW riassume in un unico prodotto qualità del design, essenzialità e pregio dei materiali.

Une solution d'angle avec un plateau plaqué bois. DHOW résume en un unique produit la qualité du design, l'essentialité et la valeur des matériaux.

Corner solution with veneered top. DHOW summarizes design quality, essentiality and quality of materials in a single product.

Solución de esquina con encimera enchapada. DHOW resume la calidad del diseño, la esencialidad y la calidad de los materiales en un solo producto.









DHOW 03





Piano curvo ed allungo a goccia in vetro, una soluzione dalla grande leggerezza stilistica che non preclude la funzionalità di utilizzo.

Avec son plateau courbe et son extension en goutte d'eau en verre, ce modèle offre une grande légèreté de style sans nuire à la fonction d'usage.

Curved top and drop-shaped extension in glass, a solution with a great stylistic lightness that does not preclude the functionality of use.

Encimera curvada y extensión en forma de gota en vidrio, una solución con una gran ligereza estilística que no excluye la funcionalidad de uso.



Finiture / Finitions / Finishings / Acabados

STRUTTURA / STRUCTURE / FRAME / ESTRUCTURA



Alluminio Lucido

ESSENZE LEGNO / ESSENCES DE BOIS / WOOD FINISHES / ACABADOS EN MADERA



NO _Noce



RLB _Rovere Bianco



RDG _Rovere Grigio



WDE _Wengé



RLN _Rovere Naturale

VETRI / VERRES / GLASS / VIDRIO



VAC _Vetro Acidato



VTR _Vetro Trasparente

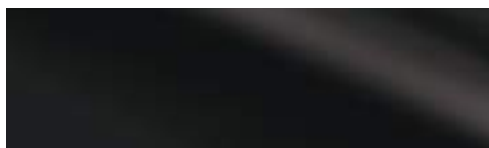

VNR _Vetro Nero



VBI _Vetro Bianco

ARMADI / ARMOIRES / CLOSETS / ARMARIOS _Pag. 222

CASSETTIERE / CAISSONS / CHEST OF DRAWERS / CAJONERAS _Pag. 230

MOBILI DI SERVIZIO / MEUBLES DE SERVICE / SERVICE CABINETS / MOBILIARIOS DE SERVICIO _Pag. 240

Moduli / Modules / Modules / Modulos

SCRIVANIE IN LEGNO / BUREAUX EN BOIS / WOODEN DESKS / ESCRITORIOS EN MADERA

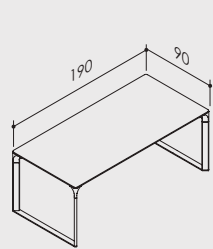

DW 190

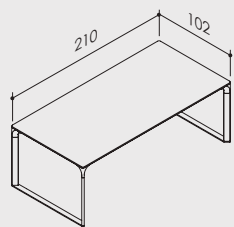

DW 210

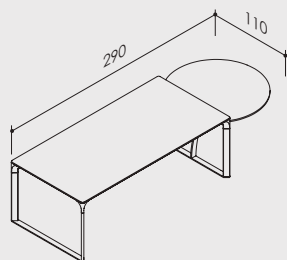

DW 290 T

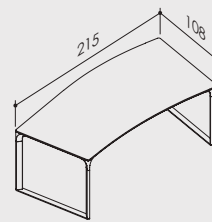

DW 215

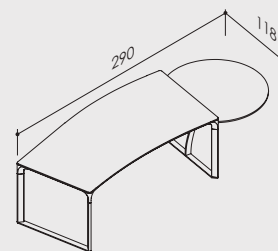

DW 290 AT

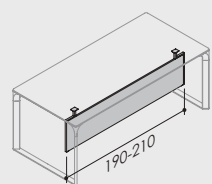

DW PL / DW PC

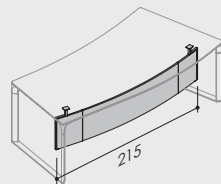

DW PAC

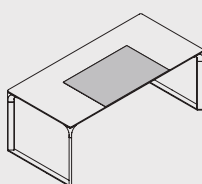

DWSMC

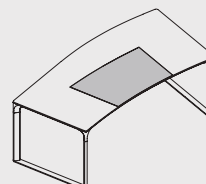

DWSMAC

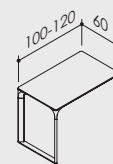

DW 100 / DW 120

TAVOLI RIUNIONE IN LEGNO / TABLES DE RÉUNION EN BOIS / WOODEN MEETING TABLES / MESAS DE REUNIONES EN MADERA

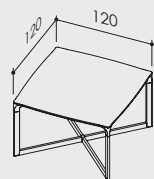

DWTQ 12

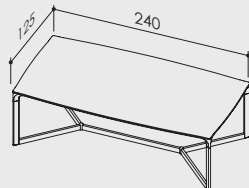

DWTC 24

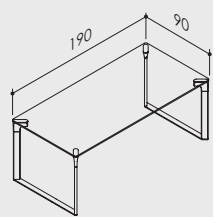
SCRIVANIE IN VETRO / BUREAUX EN VERRE / GLASS DESKS / ESCRITORIOS EN VIDRIO

DW 190 V

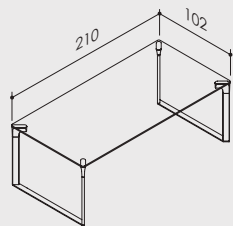

DW 210 V

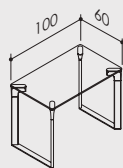

DW 30100 V

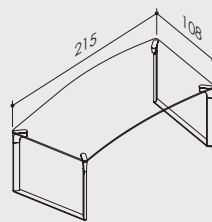

DW 215 V

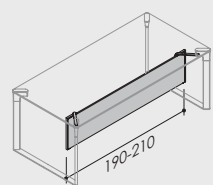

DW PL V / DW PC V

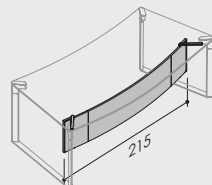

DW PAC V

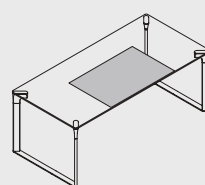

DWSMC

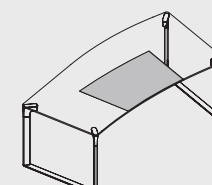

DWSMAC

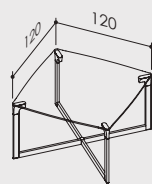
TAVOLI RIUNIONE IN VETRO / TABLES DE RÉUNION EN VERRE / GLASS MEETING DESKS / MESAS DE REUNIONES EN VIDRIO

DWTQ 12 V

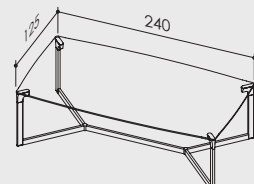

DWTC 24 V

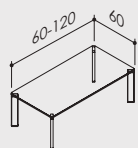
TAVOLINI IN VETRO / TABLES BASSES EN VERRE / GLASS TABLES / MESAS EN VIDRIO

DWTB V

**Caratteristiche:**

- Gambe Pannellate bordate con inserto in alluminio lucidato.
- Struttura con rivestimento in cristallo o nobilitato.
- Paratia rivestita in laminato effetto specchio.
- Cassettiera portante con top in nobilitato o cristallo.
- Piani in nobilitato sp. 38mm disponibili in 5 finiture.
- Piani in cristallo disponibili in 2 finiture.
- Personalizzazione infinita dei piani di lavoro.

Caractéristiques:

- Pieds panneaux bordés d'un insert en aluminium poli.
- Structure avec un revêtement en cristal ou en panneau anobli.
- Cloison revêtue de stratifié à effet miroir.
- Caisson porteur avec un plateau anobli ou en cristal.
- Plateaux anoblis d'une épaisseur de 38 mm disponibles en 5 finitions.
- Plateaux en cristal disponibles en 2 finitions.
- Infinité de possibilités pour personnaliser les plans de travail.

Features:

- Paneled legs edged with insert of polished aluminum.
- Structure with crystal or melamine coating.
- Bulkhead covered in mirror effect laminate.
- Load-bearing chest of drawers with melamine or crystal tops.
- Tops in melamine 38mm thick available in 5 finishes .
- Crystal tops available in 2 finishes.
- Infinite customization of working surfaces.

EXE NOX

**Características:**

- Patas paneladas con borde de inserción de aluminio pulido.
- Estructura con revestimiento de cristal o melamina.
- Mamparo revestido en laminado efecto espejo.
- Cajonera portante con encimera de melamina o cristal.
- Encimeras en melamina espesor 38 mm disponibles en 5 acabados.
- Encimeras de cristal disponibles en 2 acabados.
- Personalización infinita de encimeras de trabajo.



EXE NOX 01





Le forme geometriche essenziali delle gambe pannellate sono espressione di un design minimalista arricchito da materiali di prestigio.

Les formes géométriques essentielles des pieds panneaux sont l'expression d'un design minimaliste enrichi par des matériaux prestigieux.

The essential geometric shapes of the paneled legs are the expression of a minimalist design enriched by prestigious materials.

Las formas geométricas esenciales de las patas paneladas son la expresión de un diseño minimalista enriquecido con materiales de prestigio.





EXE NOX 02





In EXE NOX il piano di lavoro si integra con mobili di servizio dedicati, che acquistano funzione strutturale e contenitiva insieme.

Les meubles de service intégrés au plan de travail d'EXE NOX allient une fonction structurale à celle de rangement.

In EXE NOX the worktop is integrated with dedicated service units, which acquire a structural and containing function together.

En EXE NOX, la encimera está integrada con unidades de servicio dedicadas, que adquieren una función estructural y de contención a la vez.





EXE NOX 03







Le gambe pannellate possono essere personalizzate dal nobilitato o da inserti in vetro retrolaccato, incorniciati da un profilo in alluminio lucidato.

Les pieds panneaux peuvent être personnalisés par des panneaux anoblis ou des inserts en verre laqué, encadrés par un profilé en aluminium poli.

The paneled legs can be customized with melamine or back-lacquered glass inserts, framed by a polished aluminum profile.

Las patas paneladas se pueden personalizar con inserciones de melamina o vidrio retrolaqueado, enmarcadas por un perfil de aluminio pulido.

Finiture / Finitions / Finishings / Acabados

MELAMINICO LEGNO / MÉLAMINÉ DÉCOR BOIS / MELAMINE WOOD / MADERA MELAMINA

Piani di lavoro e gambe / Plans de travail et pieds / Worktops and legs / Encimeras de trabajo y patas



NC _Noce Canaletto



RS _Rovere Sbiancato



RG _Rovere Grigio



WE _Wengé



LA _Larice

MELAMINICO TINTA UNITA / MÉLAMINÉ TEINTE UNIE / PLAIN-COLORED MELAMINE / MELAMINA DE UN SOLO COLOR

Accessori / Accessoires / Accessories / Accesorios

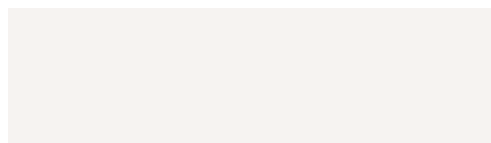

BI _Bianco



GR _Grigio



TO _Tortora

VETRI / VERRES / GLASS / VIDRIO

Piani di lavoro e inserti su gambe / Plans de travail et inserts sur pieds / Worktops and table legs inserts / Encimeras de trabajo y insertos en las patas

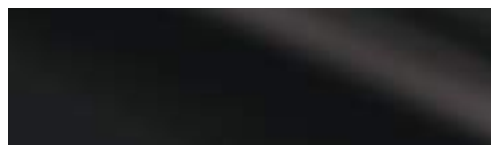

VNR _Vetro Nero



VBI _Vetro Bianco

ARMADI / ARMOIRES / CLOSETS / ARMARIOS _Pag. 222

CASSETTIERE / CAISSONS / CHEST OF DRAWERS / CAJONERAS _Pag. 230

MOBILI DI SERVIZIO / MEUBLES DE SERVICE / SERVICE CABINETS / MOBILIARIOS DE SERVICIO _Pag. 240

Moduli / Modules / Modules / Modulos

SCRIVANIE / BUREAUX / DESKS / ESCRITORIOS

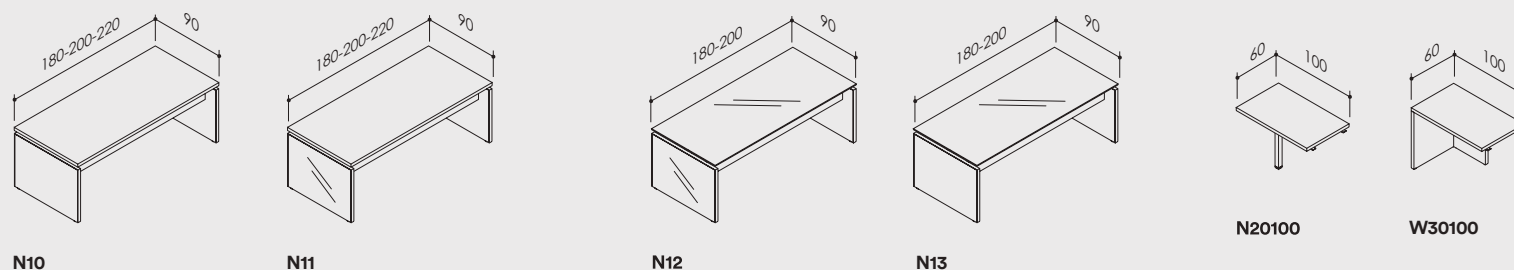

SCRIVANIE SU MOBILE DI SERVIZIO DX E SX / BUREAUX SUR MEUBLE DE SERVICE PORTEUR DROITE ET GAUCHE
 DESKS ON RIGHT/LEFT SERVICE FURNITURE / ESCRITORIOS EN MUEBLES DE SERVICIO DERECHA/IZQUIERDA

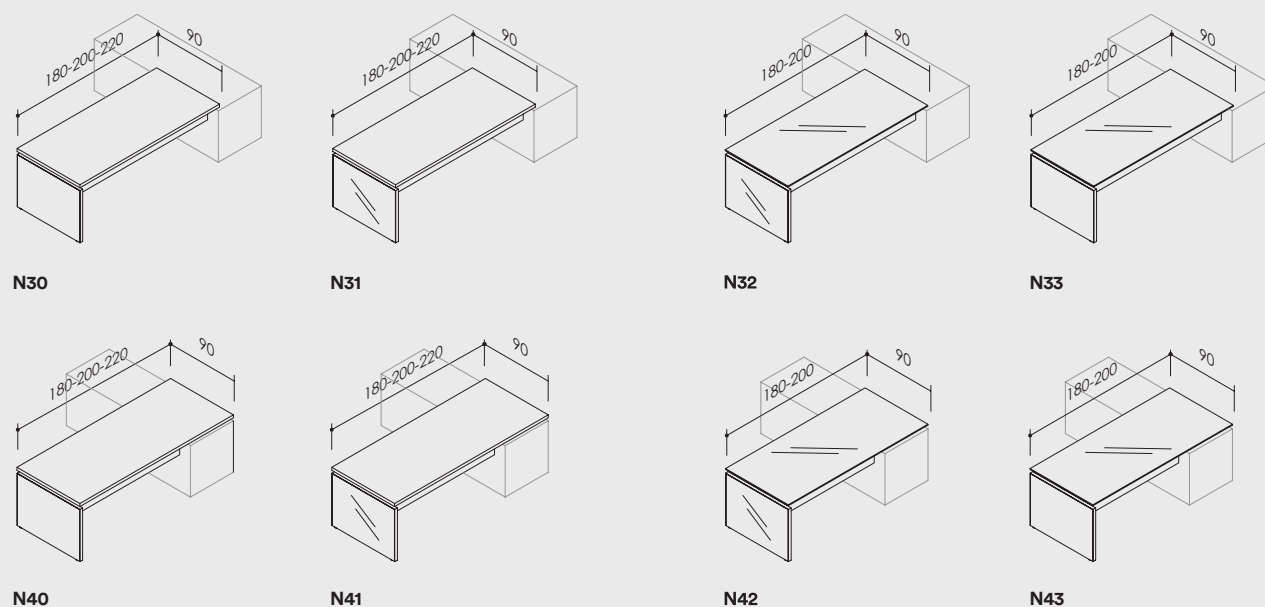

MOBILI DI SERVIZIO / MEUBLES DE SERVICE / SERVICE FURNITURE / MOBILIARIO DE SERVICIO

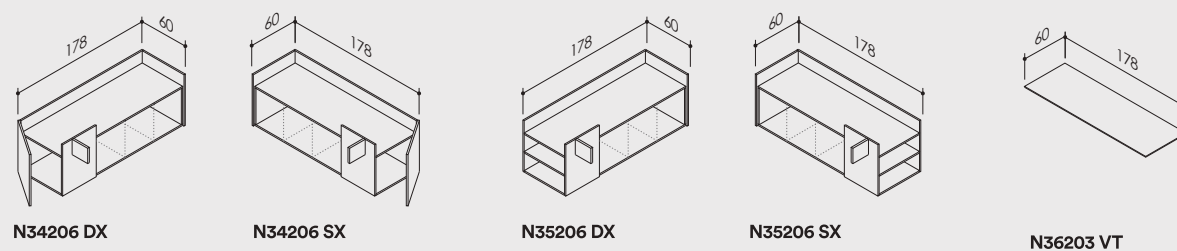

MOBILE DA PARETE / MEUBLES MURAUX / WALL FURNITURE / MUEBLES DE PARED

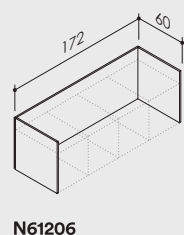

ELEMENTI PER COMPORRE MOBILI DI SERVIZIO E DA PARETE / ÉLÉMENTS POUR COMPOSER DES MEUBLES DE SERVICE ET DES MEUBLES MURAUX
 ELEMENTS TO MAKE SERVICE FURNITURE AND WALL FURNITURE / ELEMENTOS PARA COMPONER MOBILIARIO DE SERVICIO Y DE PARED

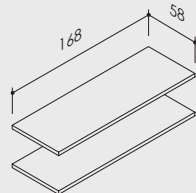
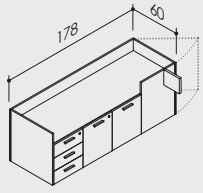

W60000

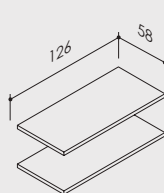

W60003



W60020



W60030



W60040



W60001/W60002

CASSETTIERA PORTANTE / CAISSON PORTEUR / LOAD-BEARING CHEST OF DRAWERS / CAJONERA PORTANTE

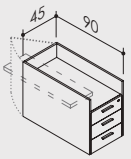

N61042 DX

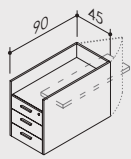

N61042 SX

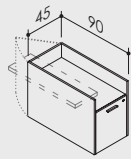

N66042 DX

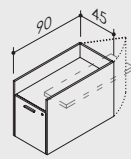

N66042 SX

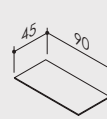

N45090 VT

TAVOLI RIUNIONE / MESAS DE REUNIONES / MEETING TABLES / MESAS DE REUNIONES

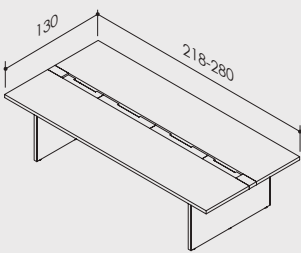

N50

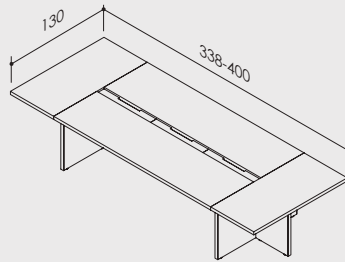

N50

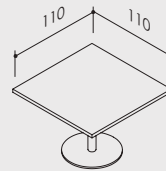

N50 110

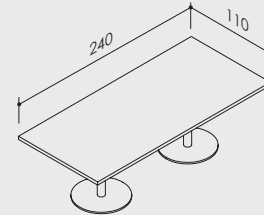

N50 240

**Caratteristiche:**

- Gambe pannellate nobilitate spessore 38 mm disponibili in 5 finiture.
- Gonna strutturale personalizzabile con 9 colorazioni.
- Piani in nobilitato disponibili in 5 finiture.
- Piani spessore 38 mm di serie.
- Nuovi allunghi su gamba pannellata disponibili in abbinamento.
- Mobili di servizio per composizioni in appoggio esterno o in sormonto.

Caractéristiques:

- Pieds panneaux nobilités de 38 mm d'épaisseur disponibles en 5 finitions.
- Voile de fond structurel personnalisable en 9 coloris.
- Plateaux nobilités disponibles en 5 finitions.
- Plateaux de série de 38mm d'épaisseur.
- Nouveaux retours sur pied panneau disponibles en combinaison.
- Meubles de service porteurs avec un appui externe ou en chevauchement pour les compositions.

Features:

- 38 mm thick melamine paneled legs available in 5 finishes.
- Customizable structural modesty panel with 9 colors.
- Melamine tops available in 5 finishes.
- 38 mm thick tops as standard.
- New extensions on paneled leg available in combination.
- Service furniture for compositions in external support or overlapping.

EXE WOOD

**Características:**

- Patas paneladas melámnicas de 38 mm de espesor disponibles en 5 acabados.
- Faldón estructural personalizable con 9 colores.
- Encimeras de melamina disponibles en 5 acabados.
- Encimeras de 38 mm de espesor de serie.
- Nuevas extensiones en la pierna con paneles disponibles en combinación.
- Mobiliario de servicio para composiciones en apoyo externo o superposición.



EXE WOOD 01









L'allungo, posizionabile sia a destra che a sinistra, aumenta la superficie della scrivania aggiungendo un comodo piano laterale.

Le retour, placé à droite ou à gauche, augmente la surface du bureau en ajoutant un plateau latéral fonctionnel.

The extension, which can be positioned both on the right and on the left, increases the surface of the desk by adding a comfortable side surface.

La extensión, que se puede colocar tanto a la derecha como a la izquierda, aumenta la superficie del escritorio añadiendo una superficie lateral cómoda.



RED Exclusive Design:

74



EXE WOOD 02





Le scrivanie per ufficio con mobile di servizio portante reversibile dx/sx, garantiscono grande capacità contenitiva e libertà compositiva.

Les bureaux avec un meuble de service porteur réversible droite/gauche garantissent une grande capacité de rangement et une liberté de composition.

The office desks with right / left reversible load-bearing service cabinet guarantee great storage capacity and compositional freedom.

Los escritorios de oficina con mueble de servicio con función portante reversible derecha / izquierda garantizan una gran capacidad de contención y libertad de composición.







Armadi e contenitori possono essere integrati facilmente con tutti i modelli SpOffice, grazie alla trasversalità delle finiture.

Des armoires et des rangements peuvent être facilement intégrés à tous les modèles SP Office grâce à la transversalité des finitions.

Cabinets and containers can be easily integrated with all Sp Office models, thanks to the transversality of the finishes.

Los armarios y contenedores se pueden integrar fácilmente con todos los modelos de SpOffice, gracias a la transversalidad de los acabados.







Le venature calde del piano in melaminico legno dialogano con le tinte più chiare dei contenitori, raggiungendo un perfetto equilibrio stilistico.

Les veines chaudes du plateau mélaminé décor bois dialoguent avec les tons plus clairs des rangements, atteignant un équilibre stylistique parfait.

The warm veins of the melamine wood top interact with the lighter colors of the containers, achieving a perfect stylistic balance.

Las venas cálidas de la encimera de madera melamina interactúan con los colores más claros de los contenedores, logrando un perfecto equilibrio estético.



Finiture / Finitions / Finishings / Acabados

MELAMINICO LEGNO / MÉLAMINÉ DÉCOR BOIS / MELAMINE WOOD / MADERA MELAMINA

Piani di lavoro e gambe / Plans de travail et pieds / Worktops and legs / Encimeras de trabajo y patas



NC_Noce Canaletto



RS_Rovere Sbiancato



RG_Rovere Grigio



WE_Wengé



LA_Larice

MELAMINICO TINTA UNITA / MÉLAMINÉ TEINTE UNIE / PLAIN-COLORED MELAMINE / MELAMINA DE UN SOLO COLOR

Accessori / Accessoires / Accessories / Accesorios

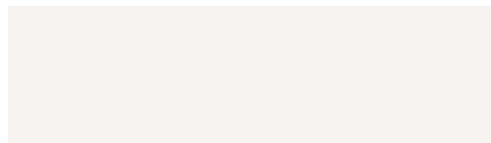

BI_Bianco



GR_Grigio



TO_Tortora

LACCATO LUCIDO E OPACO / LAQUÉ BRILLANT ET MAT / GLOSSY AND MATT LACQUER / LACADO

LAR_Arancio



LRS_Rosso



LBL_Blu



RAL a scelta / Couleurs RAL au choix
RAL to choose / RAL a elegir

TESSUTO / TISSU / TEXTURE / TEXTIL

TNR_Nero



TGR_Grigio



TBE_Beige



TBL_Blu



TCE_Celeste



TVE_Verde



TRS_Rosso



Tessuto a scelta / Tissu au choix
Texture to choose / Textil a elegir

Moduli / Modules / Modules / Modulos

SCRIVANIE / BUREAUX / DESKS / ESCRITORIOS

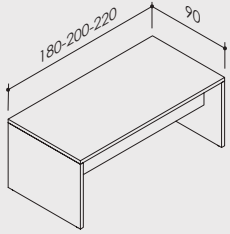

W10

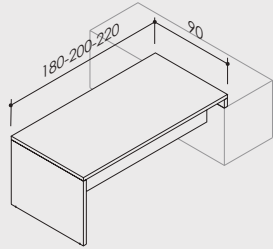

W30

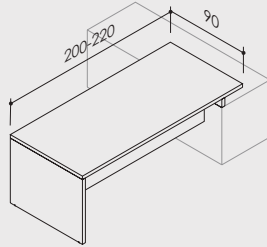

W40

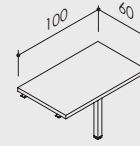

W20100

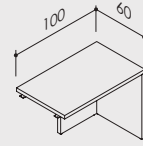

W30100

ELEMENTI PER COMPORRE MOBILI DI SERVIZIO / ÉLÉMENTS POUR COMPOSER DES MEUBLES DE SERVICE
ELEMENTS TO MAKE SERVICE FURNITURE / ELEMENTOS PARA COMPONER MOBILIARIO DE SERVICIO

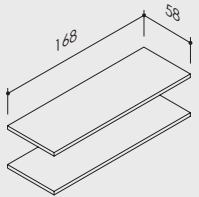

W60000

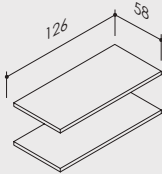

W60003

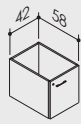

W60020



W60030



W60040



W60001/W60002

TAVOLI RIUNIONE / MESAS DE REUNIONES / MEETING TABLES / MESAS DE REUNIONES

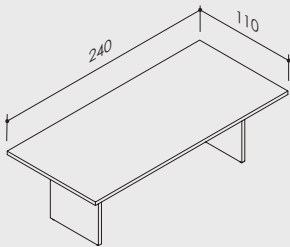

W40 240

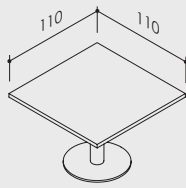

W40 110

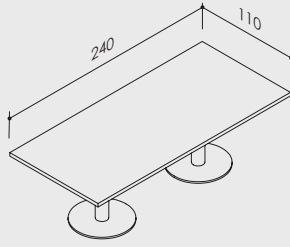

W50 240

**Caratteristiche:**

- Struttura con gambe a sezione rettangolare in acciaio cromato o verniciato in 3 finiture.
- Struttura Mat con struttura ad anello.
- Struttura Rial con struttura a portale aperto.
- Doppia trave portante.
- Piani in nobilitato disponibili in 9 finiture .
- Piani in cristallo disponibili in 2 finiture .
- Mobili di servizio per composizioni in appoggio.

Caractéristiques:

- Structure avec pieds à section rectangulaire en acier chromé ou vernis en 3 finitions.
- Structure Mat en anneau.
- Structure Rial en anneau ouvert.
- Double poutre portante.
- Plateaux anoblis disponibles en 9 finitions.
- Plateaux en cristal disponibles en 2 finitions.
- Meubles de service porteurs pour les compositions.

Features:

- Structure with rectangular section legs in chromed or painted steel in 3 finishes.
- Mat structure with ring structure.
- Rial structure with open portal structure.
- Double supporting beam.
- Melamine tops available in 9 finishes.
- Crystal tops available in 2 finishes.
- Service furniture for support compositions.

MATeRIAL



Características:

- Estructura con patas de sección rectangular en acero cromado o pintado en 3 acabados.
- Estructura Mat con estructura de anillos.
- Estructura de Rial con estructura con puerta abierta.
- Doble viga portante.
- Encimeras de melamina disponibles en 9 acabados.
- Encimeras de cristal disponibles en 2 acabados.
- Mobiliario de servicio para composiciones en apoyo.

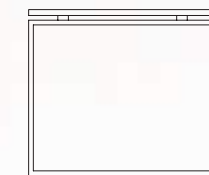

Gamba Mat

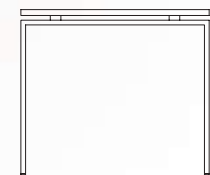

Gamba Rial







Gamba Mat

Linee sobrie e design essenziale, MateRial soddisfa qualsiasi esigenza di layout e stile, adattandosi perfettamente ad ambienti direzionali ed operativi.

Avec ses lignes sobres et son design essentiel, MateRial répond à toutes les exigences d'aménagement et de style en s'adaptant parfaitement aux espaces opératifs et de direction.

Sober lines and essential design, MateRial satisfies any layout and style needs, adapting perfectly to executive and operational environments.

De líneas sobrias y diseño esencial, MateRial satisface cualquier necesidad de diseño y estilo, adaptándose perfectamente a los entornos ejecutivos y operativos.





Gamba Rial









Gamba Rial

I mobili di servizio assolvono alle esigenze contenitive e creano interessanti giochi di volumi con i piani.

Les meubles de services répondent aux exigences de rangement et créent avec les plateaux d'intéressants jeux de volumes.

The service units fulfill the storage needs and create interesting plays of volumes with the tops.

El mobiliario de servicio satisface las necesidades de contención y crea interesantes juegos de volúmenes con las encimeras.













Gamba Mat

Le postazioni di lavoro condivise sono completamente accessoriabili e integrabili con i contenitori universali.

Les postes de travail partagés peuvent être entièrement équipés et intégrés à des rangements universels.

The shared workstations can be fully accessorized and integrated with universal containers.

Las estaciones de trabajo compartidas se pueden equipar por completo e integrarse con contenedores universales.





Gamba Mat

Le cassettiere in metallo su ruote con classificatore, completano le postazioni creando ambienti di lavoro efficienti ed organizzati.

Les caissons en métal sur roulettes avec classeur complètent les postes, créant un espace de travail efficace et organisé.

The metal drawer units on wheels with filing cabinet complete the workstations, creating efficient and organized work environments.

Las cajoneras metálicas sobre ruedas con archivador completan los puestos de trabajo, creando entornos de trabajo eficientes y organizados.



Finiture / Finitions / Finishings / Acabados

STRUTTURA / STRUCTURE / FRAME / ESTRUCTURA



AL_Aluminio

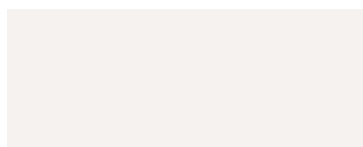

BI_Bianco



FE_Ferro



CR_Cromo

MELAMINICO LEGNO / MÉLAMINÉ DÉCOR BOIS / MELAMINE WOOD / MADERA MELAMINA



NC_Noce Canaletto



RS_Rovere Sbiancato



RG_Rovere Grigio



WE_Wengé



LA_Larice



OL_Olmo

MELAMINICO TINTA UNITA / MÉLAMINÉ TEINTE UNIE / PLAIN-COLORED MELAMINE / MELAMINA DE UN SOLO COLOR

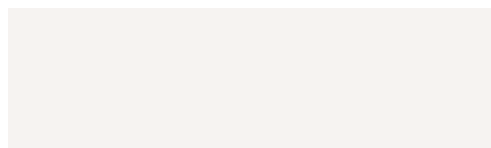

BI_Bianco



GR_Grigio



TO_Tortora

VETRI / VERRÉS / GLASS / VIDRIO

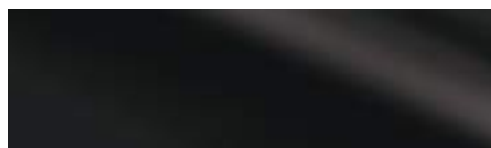

VNR_Vetro Nero



VBI_Vetro Bianco

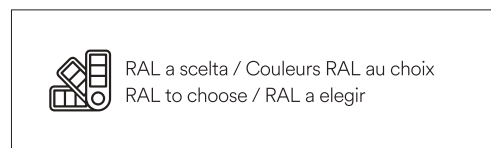

VSP_Vetro colore a scelta



RAL a scelta / Couleurs RAL au choix
RAL to choose / RAL a elegir

LACCATO LUCIDO E OPACO / LAQUÉ BRILLANT ET MAT / GLOSSY AND MATT LACQUER / LACADO

LAR _Arancio



LRS _Rosso



LBL _Blu



RAL a scelta / Couleurs RAL au choix
RAL to choose / RAL a elegir

TESSUTO / TISSU / TEXTURE / TEXTIL

TNR _Nero



TGR _Grigio



TBE _Beige



TBL _Blu



TCE _Celeste



TVE _Verde



TRS _Rosso



Tessuto a scelta / Tissu au choix
Texture to choose / Textil a elegir

Moduli / Modules / Modules / Modulos

SCRIVANIE GAMBA MAT / BUREAUX PIEDS MAT / MAT LEG DESKS / ESCRITORIOS PATA MAT

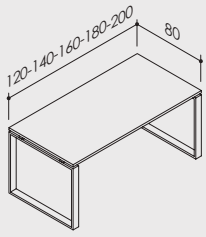

M10

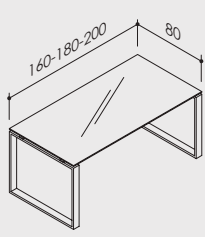

M10 V

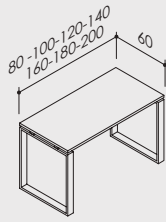

M30

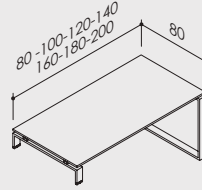

M10M

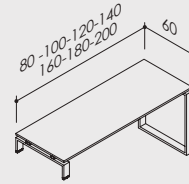

M30M

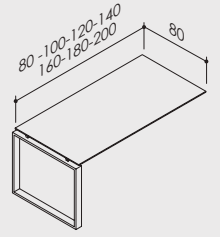

M15

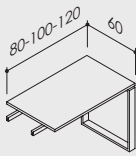

M20

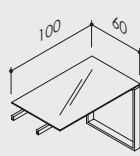

M20 100 V

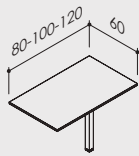

X20

BENCH GAMBA MAT / BUREAUX BENCH PIEDS MAT / MAT LEG BENCH / BENCH PATA MAT

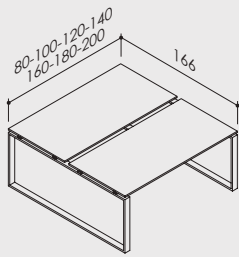

M60

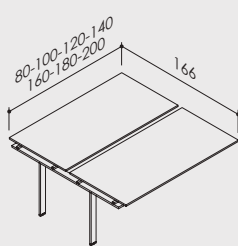

M65

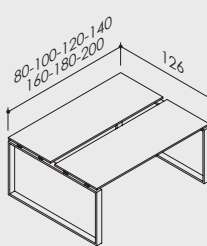

M50

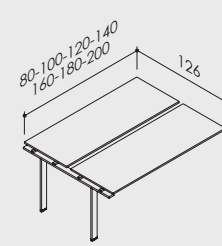

M55

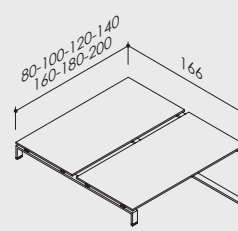

M60M

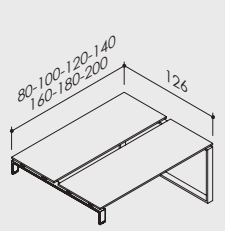

M50M

TAVOLI RIUNIONE GAMBA MAT / TABLES DE RÉUNION PIEDS MAT / MAT LEG MEETING TABLES / MESAS DE REUNIONES PATA MAT

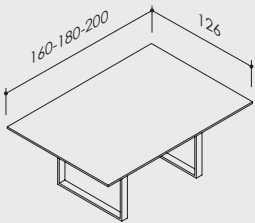

M41

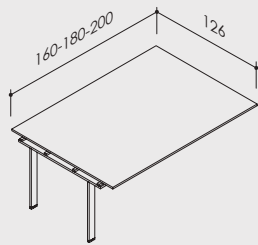

M42

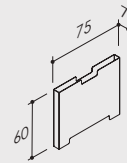

A17

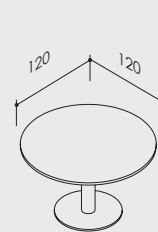

X11 120

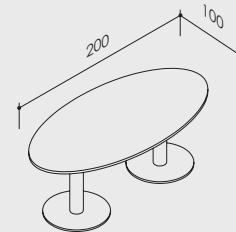

X12 200

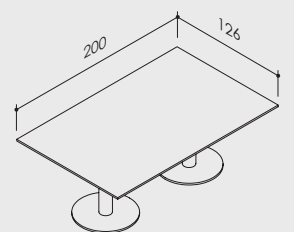

X10 200

TAVOLINI GAMBA MAT / TABLES BASSES PIEDS MAT / MAT LEG TABLES / MESAS PATA MAT

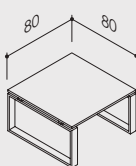

M45 080

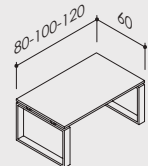

M46

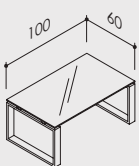

M46 100 V

SCRIVANIE GAMBA RIAL / BUREAUX PIEDS RIAL / RIAL LEG DESKS / ESCRITORIOS PATA RIAL

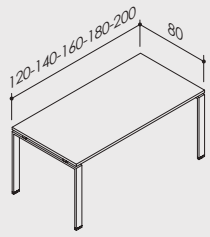

R10

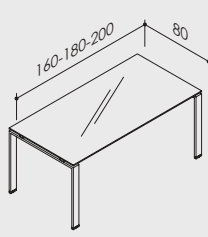

R10 V

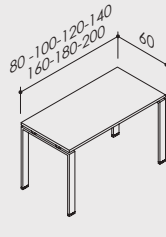

R30

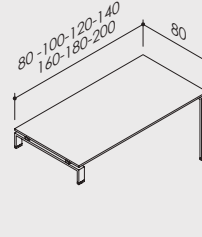

R10M

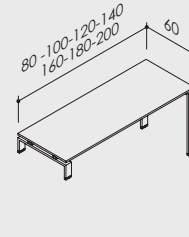

R30M

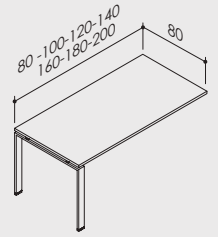

R15

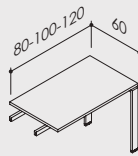

R20

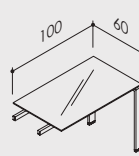

R20 100 V

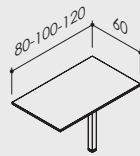

X20

BENCH GAMBA RIAL / BUREAUX BENCH PIEDS RIAL / RIAL LEG BENCH / BENCH PATA RIAL

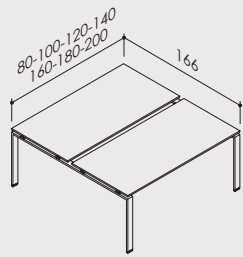

R60

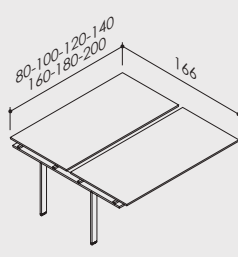

R65

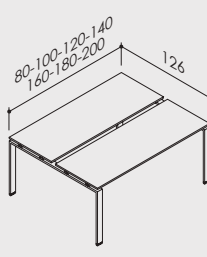

R50

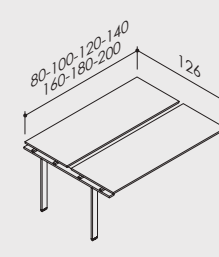

R55

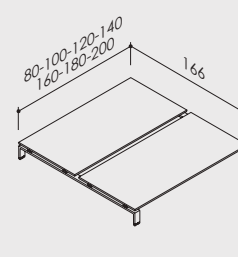

R60M

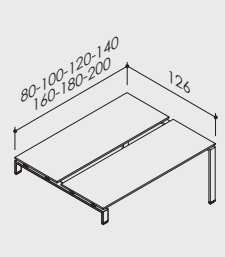

R50M

TAVOLI RIUNIONE GAMBA RIAL / TABLES DE RÉUNION PIEDS RIAL / RIAL LEG MEETING TABLES / MESAS DE REUNIONES PATA RIAL

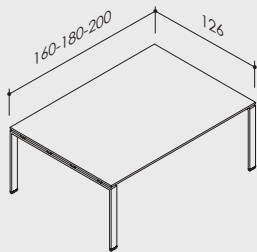

R41

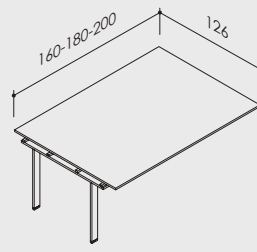

R42

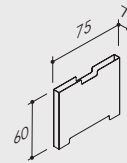

A17

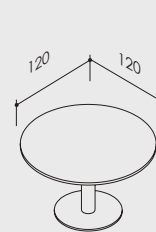

X11 120

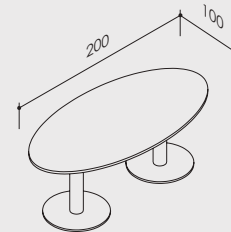

X12 200

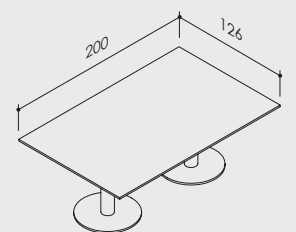

X10 200

TAVOLINI GAMBA RIAL / TABLES BASSES PIEDS RIAL / RIAL LEG TABLES / MESAS PATA RIAL

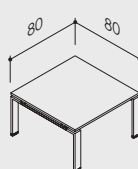

R45 080

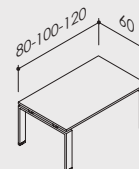

R46

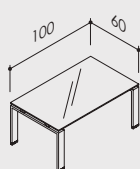

R46 100 V

**Caratteristiche:**

- Doppia soluzione di struttura con gamba in lamiera presso-piegata (Square) o conificata (Prestige).
- Strutture disponibili in acciaio cromato e verniciato in 3 finiture.
- Piedini di regolazione in acciaio cromato di serie per la gamba conificata.
- Telaio perimetrale non a vista.
- Piani in nobilitato disponibili in 9 finiture.
- Piani in cristallo disponibili in 2 finiture.

Caractéristiques:

- Double solution de structure avec des pieds en tôle pliée à la presse (Square) ou conifiés (Prestige).
- Structures disponibles en acier chromé et vernis en 3 finitions.
- Pieds niveleurs réglables de série en acier chromé pour les pieds conifiés.
- Châssis périmétral caché.
- Plateaux anoblis disponibles en 9 finitions.
- Plateaux en cristal disponibles en 2 finitions.

Features:

- Double solution of structure with leg in press-bent (Square) or tapered (Prestige) sheet metal.
- Structures available in chromed and painted steel in 3 finishes.
- Standard chromed steel adjustment feet for the tapered leg.
- Perimeter frame not visible.
- Melamine tops available in 9 finishes.
- Crystal tops available in 2 finishes.

SQUARE PRESTIGE



Características:

- Doble solución de estructura con pata en chapa plegada a presión (Square) o cónica (Prestige).
- Estructuras disponibles en acero cromado y pintado en 3 acabados.
- Patas de ajuste de acero cromado estándar para la pata cónica.
- Marco perimetral no visible.
- Encimeras de melamina disponibles en 9 acabados.
- Encimeras de cristal disponibles en 2 acabados.

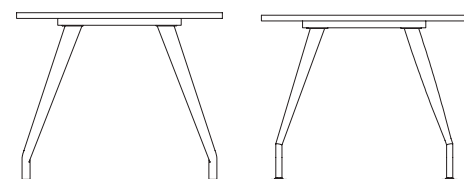

Gamba Square

Gamba Prestige





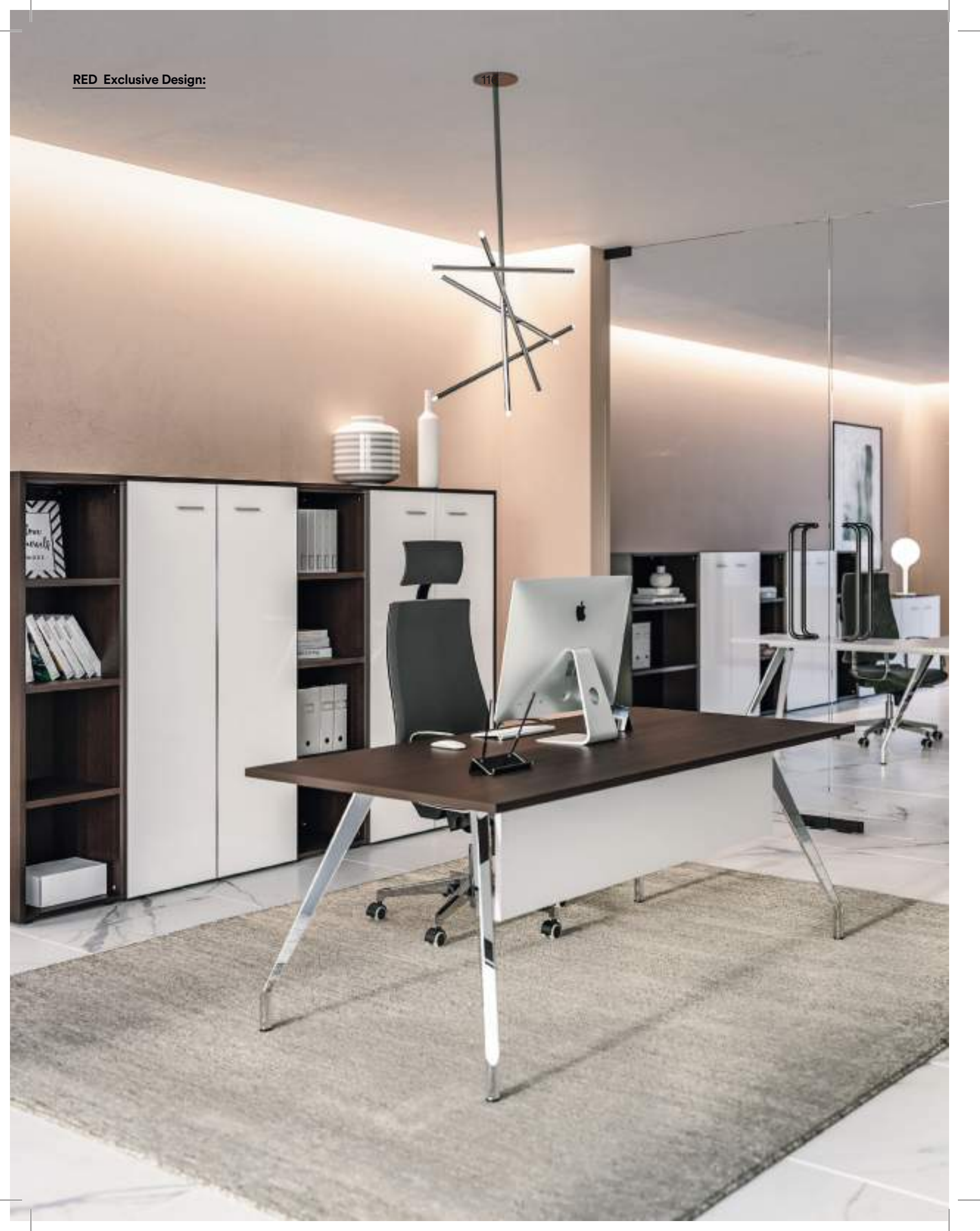



Scrivania con gamba a cavalletto Square in acciaio cromato e piano in melaminico legno o vetro, un abbinamento di grande eleganza.

Le bureau avec des pieds tréteaux Square en acier chromé et un plateau en mélaminé décor bois ou en verre présente une association d'une grande élégance.

Desk Square with trestle leg in chromed steel and top in melamine wood or glass, a combination of great elegance.

Escritorio con pata con caballete Square en acero cromado y encimera en madera melamina o en vidrio, una combinación de gran elegancia.







PRESTIGE 02



RED Exclusive Design:

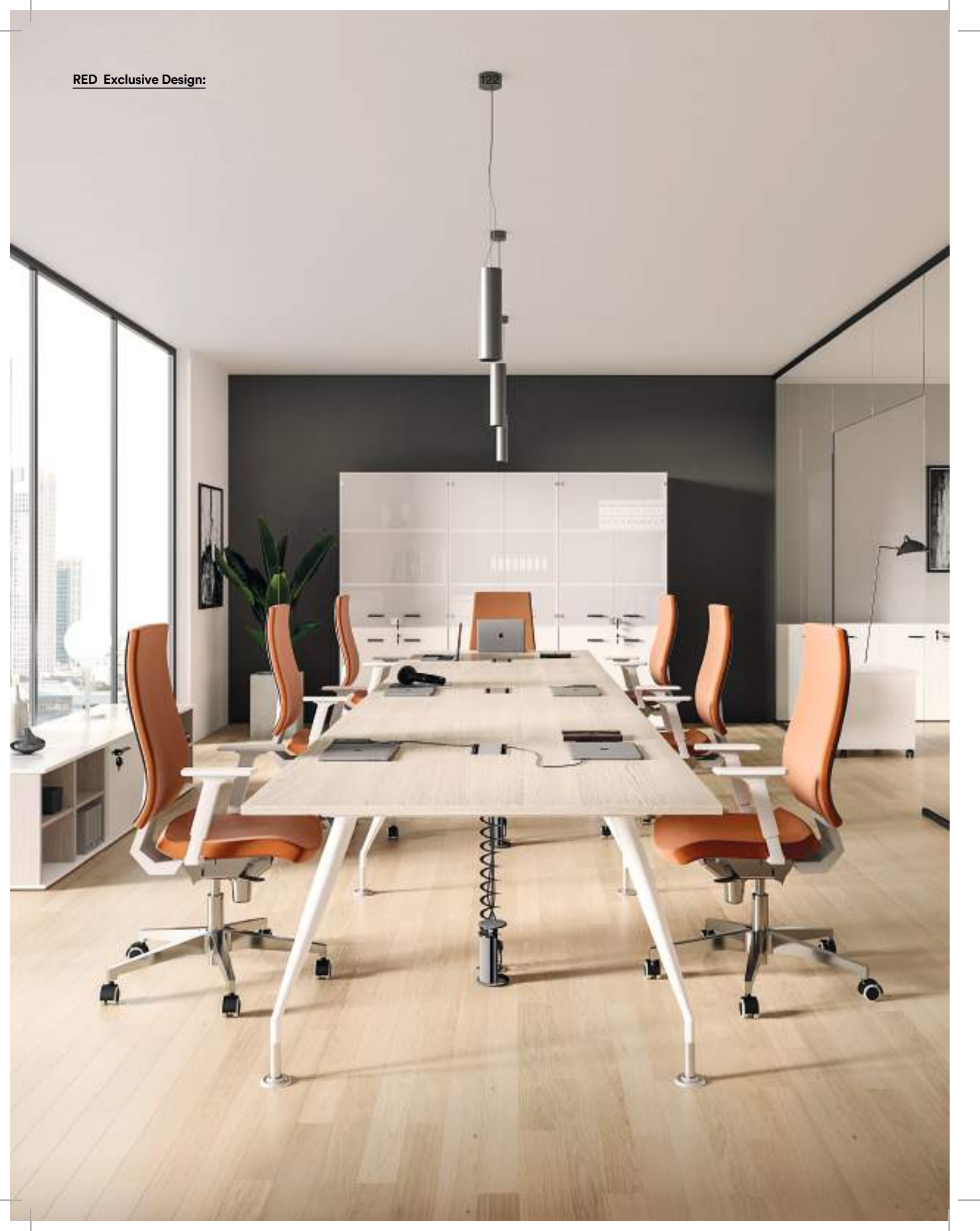



La struttura Prestige si caratterizza per la sua essenzialità e consente di realizzare scrivanie singole o tavoli riunione, con ampia scelta di finiture.

La structure Prestige se caractérise par ses lignes essentielles et permet de réaliser des bureaux individuels ou des tables de réunions, avec un large choix de finitions.

The Prestige structure is characterized by its essentiality and allows the creation of single desks or meeting tables, with a wide choice of finishes.

La estructura Prestige se caracteriza por su esencialidad y permite la creación de escritorios individuales o mesas de reunión, con una amplia variedad de acabados.



SQUARE 03





Scrivania con allungo: una soluzione efficiente che risponde alla necessità di avere superfici di lavoro aggiuntive con grande essenzialità estetica.

Le bureau avec retour : une solution efficace qui répond à la nécessité de surfaces de travail supplémentaires allée à un design essentiel.

Desk with extension: an efficient solution that responds to the need to have additional work surfaces with great aesthetic essentiality.

Escritorio con extensión: una solución eficiente que responde a la necesidad de superficies de trabajo adicionales con gran esencialidad estética.



Finiture / Finitions / Finishings / Acabados

STRUTTURA / STRUCTURE / FRAME / ESTRUCTURA



AL_Aluminio

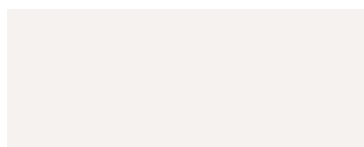

BI_Bianco



NR_Nero



CR_Cromo

MELAMINICO LEGNO / MÉLAMINÉ DÉCOR BOIS / MELAMINE WOOD / MADERA MELAMINA



NC_Noce Canaletto



RS_Rovere Sbiancato



RG_Rovere Grigio



WE_Wengé



LA_Larice



OL_Olmo

MELAMINICO TINTA UNITA / MÉLAMINÉ TEINTE UNIE / PLAIN-COLORED MELAMINE / MELAMINA DE UN SOLO COLOR

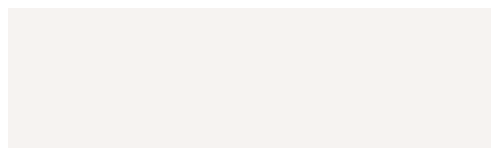

BI_Bianco



GR_Grigio



TO_Tortora

VETRI / VERRÉS / GLASS / VIDRIO

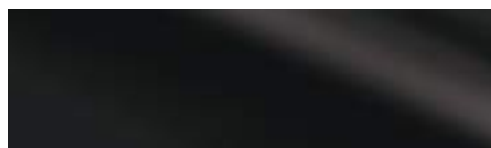

VNR_Vetro Nero



VBI_Vetro Bianco

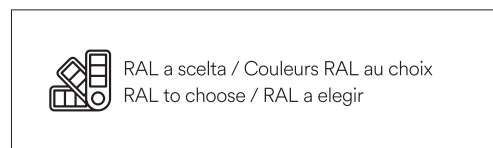

VSP_Vetro colore a scelta



RAL a scelta / Couleurs RAL au choix
RAL to choose / RAL a elegir

LACCATO LUCIDO E OPACO / LAQUÉ BRILLANT ET MAT / GLOSSY AND MATT LACQUER / LACADO

LAR _Arancio



LRS _Rosso



LBL _Blu



RAL a scelta / Couleurs RAL au choix
RAL to choose / RAL a elegir

TESSUTO / TISSU / TEXTURE / TEXTIL

TNR _Nero



TGR _Grigio



TBE _Beige



TBL _Blu



TCE _Celeste



TVE _Verde



TRS _Rosso



Tessuto a scelta / Tissu au choix
Texture to choose / Textil a elegir

Moduli / Modules / Modules / Modulos

SCRIVANIE GAMBA SQUARE / BUREAUX PIEDS SQUARE / SQUARE LEG DESKS / ESCRITORIOS PATA SQUARE

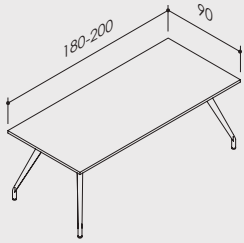

Q10

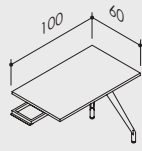

Q20 100

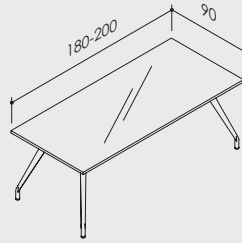

Q10 V

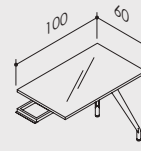

Q20 100 V

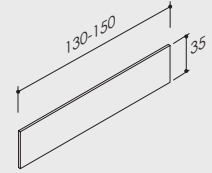

P50

TAVOLI RIUNIONE GAMBA SQUARE / TABLES DE RÉUNION PIEDS SQUARE / SQUARE LEG MEETING TABLES / MESAS DE REUNIONES PATA SQUARE

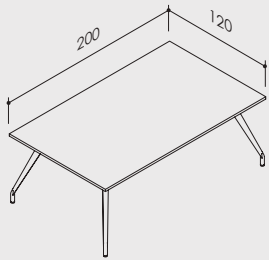

Q40 200

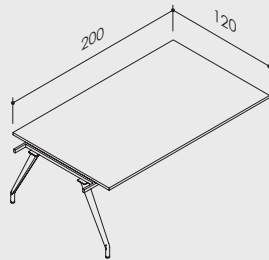

Q41 200

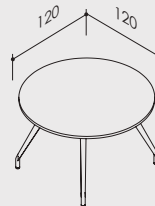

Q43 120

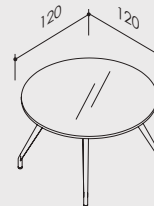

Q43 120 V

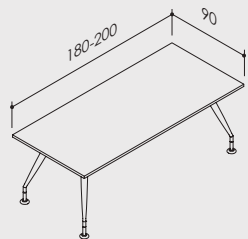
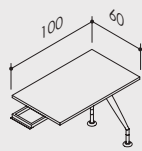
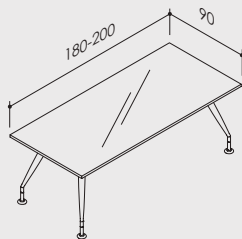
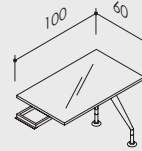
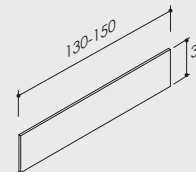
SCRIVANIE GAMBA PRESTIGE / BUREAUX PIEDS PRESTIGE / PRESTIGE LEG DESKS / ESCRITORIOS PATA PRESTIGE
**P10****P20 100****P10 V****P20 100 V****P50**

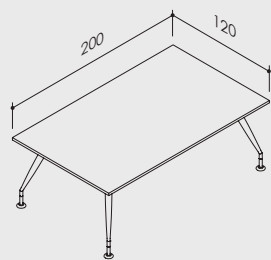
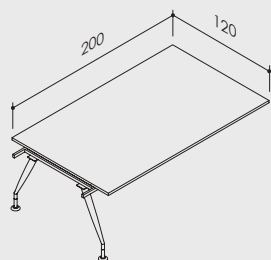
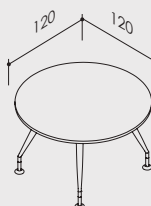
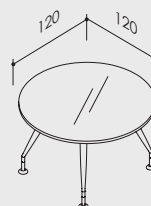
TAVOLI RIUNIONE GAMBA PRESTIGE / TABLES DE RÉUNION PIEDS PRESTIGE / PRESTIGE LEG MEETING TABLES / MESAS DE REUNIONES PATA PRESTIGE
**P40 200****P41 200****P43 120****P43 120 V**

**Caratteristiche:**

- Struttura con gambe a sezione quadrata in acciaio verniciato in 3 finiture.
- Struttura monotrave con aggancio veloce ad innesto senza utilizzo di viti.
- Nuova struttura ad "A" disponibile in versione tutta metallo in 3 finiture.
- Nuova struttura Scab Wood ad "A" con impiego congiunto di metallo e massello di rovere.
- Piani in nobilitato disponibili in 9 finiture.
- Mobili di servizio per composizioni in appoggio.
- Infinite combinazioni su misura.

Caractéristiques:

- Structure avec pieds à section carrée en acier vernis en 3 finitions.
- Structure monopoutre à montage rapide par emboîtement sans utilisation de vis.
- Nouvelle structure en « A » disponible dans une version entièrement en métal en 3 finitions.
- Nouvelle structure Scab Wood en « A » utilisant conjointement le métal et le chêne massif.
- Plateaux anoblis disponibles en 9 finitions.
- Meubles de service porteurs pour les compositions.
- Infinité de combinaisons sur mesure.

Features:

- Structure with square section legs in painted steel in 3 finishes.
- Single beam structure with quick hooking with coupling without the use of screws.
- New "A" structure available in all metal versions in 3 finishes.
- New Scab Wood "A" structure with a combined use of metal and solid oak.
- Melamine tops available in 9 finishes.
- Service furniture for support compositions.
- Infinite tailor-made combinations.

SCAB



Características:

- Estructura con patas de sección cuadrada en acero pintado en 3 acabados.
- Estructura de una viga con acoplamiento rápido acoplable sin el uso de tornillos.
- Nueva estructura en forma de "A" disponible en versión totalmente metálica en 3 acabados.
- Nueva estructura Scab Wood "A" con uso conjunto de metal y roble macizo.
- Encimeras de melamina disponibles en 9 acabados.
- Mobiliario de servicio para composiciones de soporte.
- Infinitas combinaciones a medida.

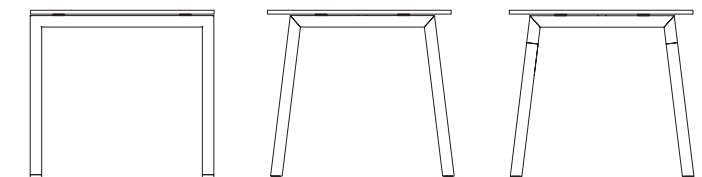

Gamba C

Gamba A

Gamba W



SCAB 01



RED Exclusive Design:





Scab Wood

SCAB è un sistema molto versatile che propone tre tipologie di gambe ed offre soluzioni ideali per postazioni di lavoro singole o multiple.

SCAB est un système polyvalent qui propose trois types de pieds et offre des solutions idéales pour les postes de travail individuels ou partagés.

SCAB is a very versatile system that proposes three types of legs and offers ideal solutions for single or multiple workstations.

SCAB es un sistema muy versátil que ofrece tres tipos de patas y ofrece soluciones ideales para estaciones de trabajo únicas o múltiples.



SCAB 02

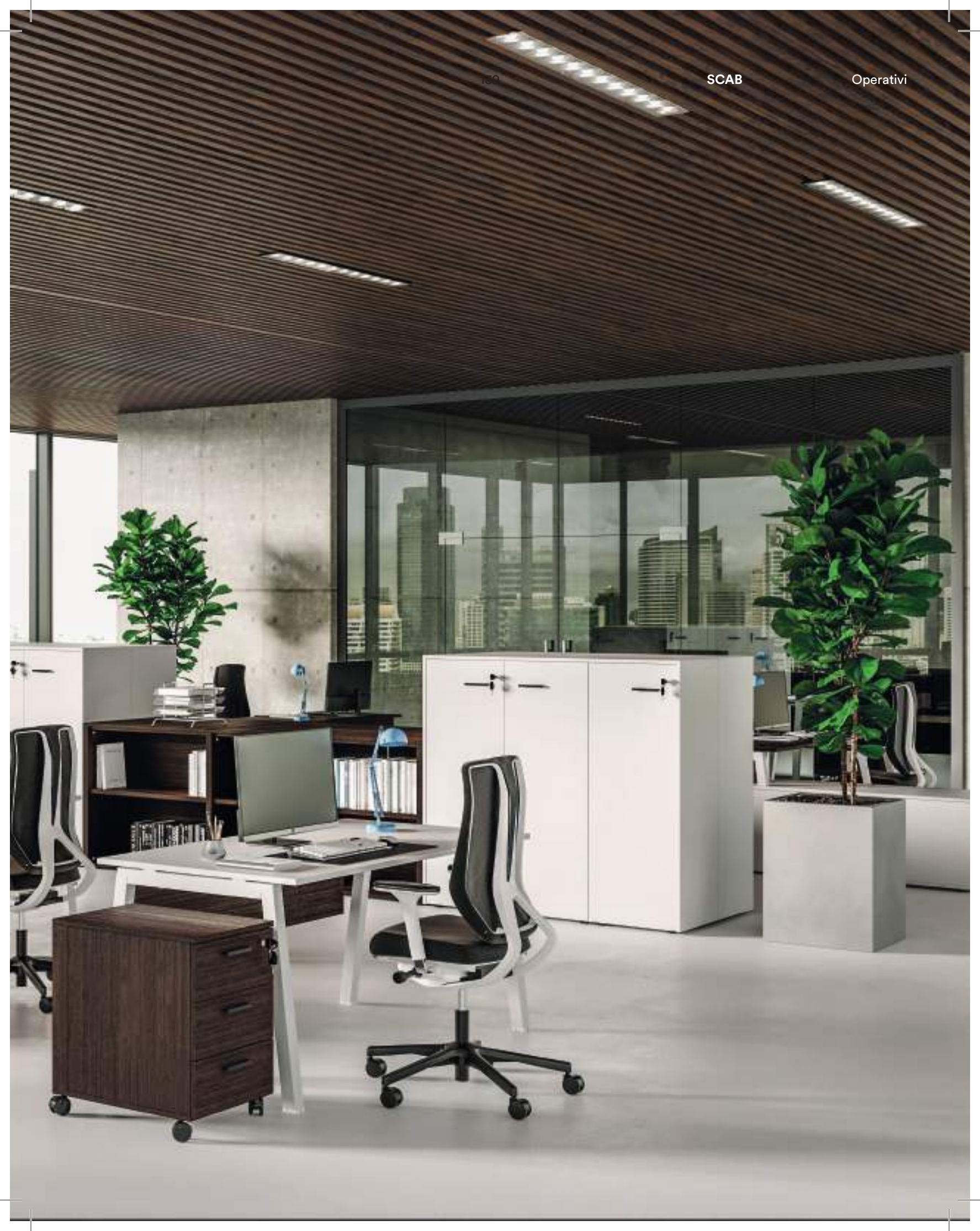



Scab A

Le scrivanie multiple sono ideali per arredare ambienti open space in cui si predilige il lavoro di squadra.

Les bureaux partagés sont l'idéal pour l'aménagement d'un espace en open space où le travail en équipe est privilégié.

Multiple desks are ideal for furnishing open space environments where teamwork is preferred.

Los escritorios múltiples son ideales para amueblar entornos de espacios abiertos donde se prefiere el trabajo en equipo.





SCAB 03







Scab C

SCAB propone tavoli riunioni modulari. I tavoli possono essere attrezzati con top acces elettrificati o semplici, ed accessori universali per la gestione dei cavi.

SCAB propose des tables de réunion modulaires. Les tables peuvent être équipées de passe-câbles électrifiés ou non, et d'accessoires universels pour la gestion des câbles.

SCAB offers modular meeting tables. The tables can be equipped with electrified or simple top access, and universal accessories for the cable management.

SCAB ofrece mesas de reuniones modulares. Las mesas se pueden equipar con acceso superior electrificado o simple, y accesorios universales para la gestión de cables.

Finiture / Finitions / Finishings / Acabados

STRUTTURA SCAB "A" E "C" / STRUCTURE SCAB "A" ET "C" / SCAB "A" AND "C" FRAME / ESTRUCTURA SCAB "A" Y "C"



AL_Alluminio

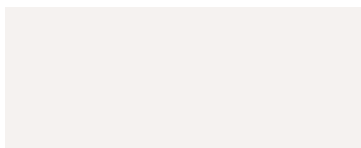

BI_Bianco



FE_Ferro

STRUTTURA SCAB WOOD / STRUCTURE SCAB WOOD / SCAB WOOD FRAME / ESTRUCTURA SCAB WOOD



AL_Alluminio

RWE RNC RNA

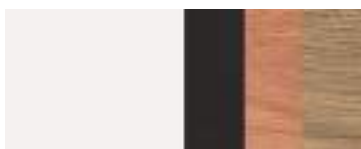

BI_Bianco

RWE RNC RNA

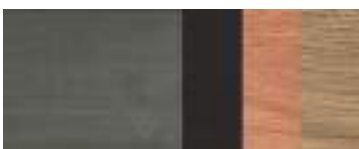

FE_Ferro

RWE RNC RNA



RWE_Rovere tinto Wengé



RNC_Rovere tinto Noce



RNA_Rovere tinto Naturale

MELAMINICO LEGNO / MÉLAMINÉ DÉCOR BOIS / MELAMINE WOOD / MADERA MELAMINA



NC_Noce Canaletto



RS_Rovere Sbiancato



RG_Rovere Grigio



WE_Wengé



LA_Larice



OL_Olmo

MELAMINICO TINTA UNITA / MÉLAMINÉ TEINTE UNIE / PLAIN-COLORED MELAMINE / MELAMINA DE UN SOLO COLOR

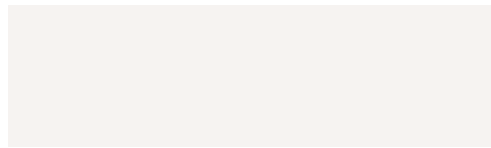

BI_Bianco



GR_Grigio



TO_Tortora

LACCATO LUCIDO E OPACO / LAQUÉ BRILLANT ET MAT / GLOSSY AND MATT LACQUER / LACADO

LAR_Arancio



LRS_Rosso



LBL_Blu



RAL a scelta / Couleurs RAL au choix
RAL to choose / RAL a elegir

TESSUTO / TISSU / TEXTURE / TEXTIL

TNR_Nero



TGR_Grigio



TBE_Beige



TBL_Blu



TCE_Celeste



TVE_Verde



TRS_Rosso



Tessuto a scelta / Tissu au choix
Texture to choose / Textil a elegir

Moduli / Modules / Modules / Modulos

SCRIVANIE GAMBA "C" / BUREAUX PIEDS EN "C" / "C" LEG DESKS / ESCRITORIOS PATA "C"

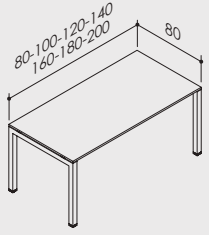

S10

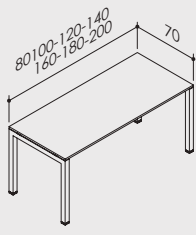

S11

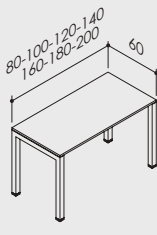

S30

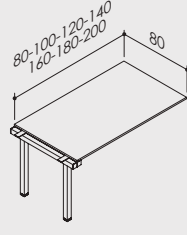

S15

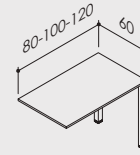

S20

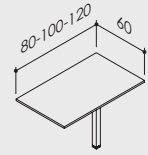

X20

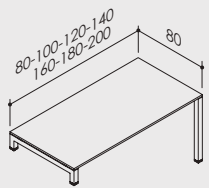

S10M

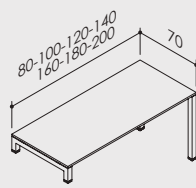

S11M

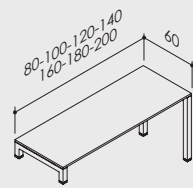

S30M

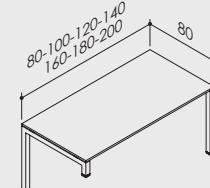

S10T

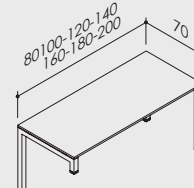

S11T

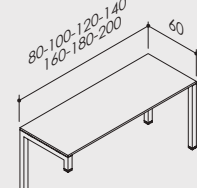

S30T

SCRIVANIE COMPATTE GAMBA "C" / BUREAUX COMPACTS PIEDS EN "C" / "C" LEG COMPACT DESKS / ESCRITORIOS COMPACTOS PATA "C"

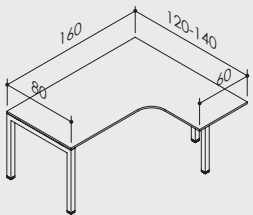

S91 DX

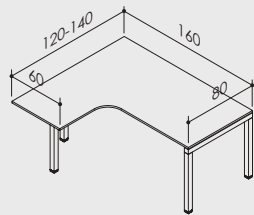

S91 SX

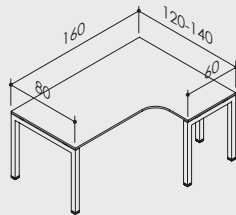

S90 DX

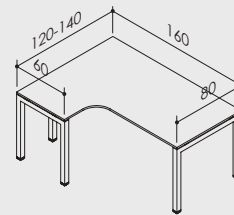

S90 SX

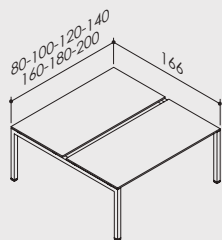
BENCH GAMBA "C" / BUREAUX BENCH PIEDS EN "C" / "C" LEG BENCH / BENCH PATA "C"

S60

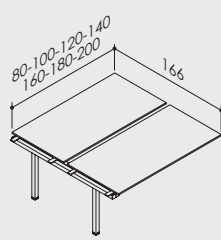

S65

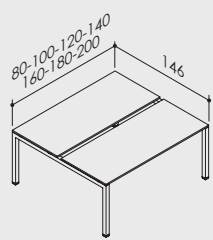

S61

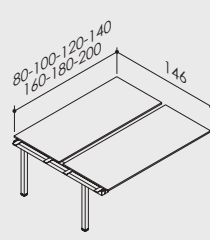

S66

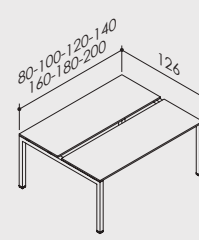

S50

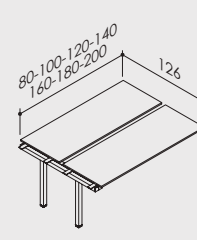

S55

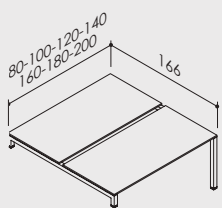

S60M

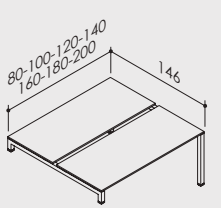

S61M

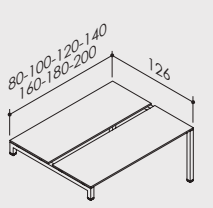

S50M

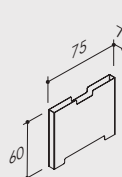

A17

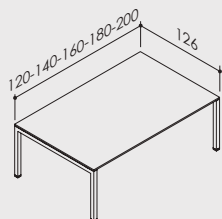
TAVOLI RIUNIONE GAMBA "C" / TABLES DE RÉUNION PIED EN "C" / "C" LEG MEETING TABLES / MESAS DE REUNIONES PATA "C"

S40

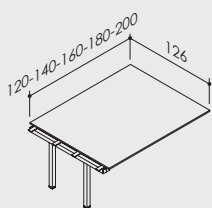

S41

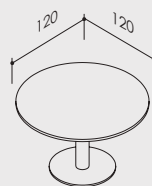

X11 120

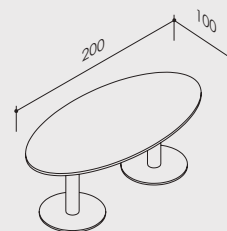

X12 200

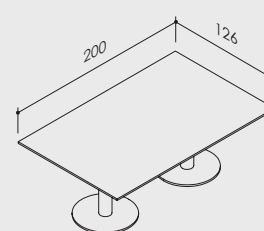

X10 200

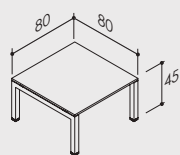
TAVOLINI GAMBA "C" / TABLES PIED EN "C" / "C" LEG TABLES / MESAS PATA "C"

S45 080

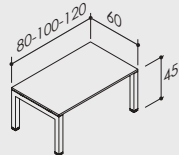

S46

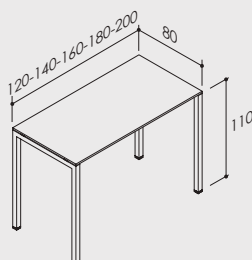

S10H

Moduli / Modules / Modules / Modulos

SCRIVANIE GAMBE "A" E "W" / BUREAUX PIEDS EN "A" ET EN "W" / "A" AND "W" LEG DESKS / ESCRITORIOS PATA "A" Y "E"

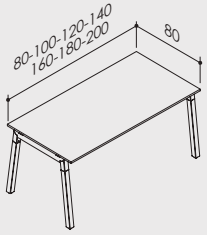

S10A / S10W

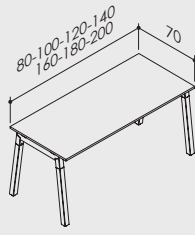

S11A / S11W

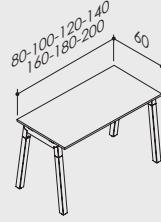

S30A / S30W

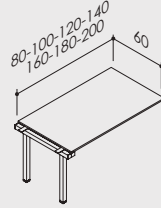

S15A / S15W

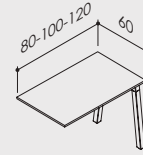

S20A / S20W

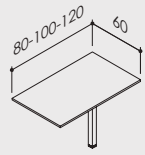

X20

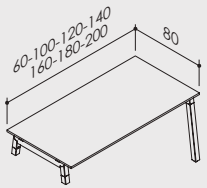

S10AM / S10WM

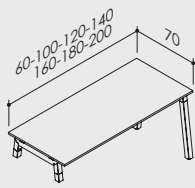

S11AM / S11WM

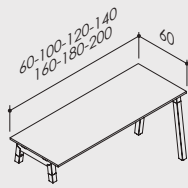

S30AM / S30WM

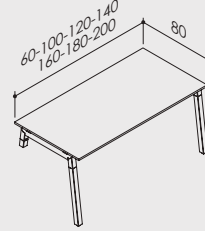

S10AT / S10WT

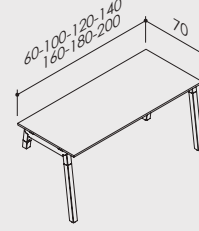

S11AT / S11WT

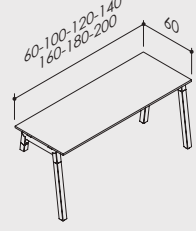

S30AT / S30WT

SCRIVANIE COMPATTE GAMBE "A" E "W" / BUREAUX COMPACTS PIEDS EN "A" ET EN "W" / "A" AND "W" LEG COMPACT DESKS / ESCRITORIOS COMPACTOS PATA "A" Y "E"

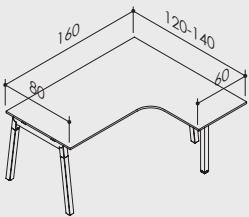

S91A DX / S91W DX

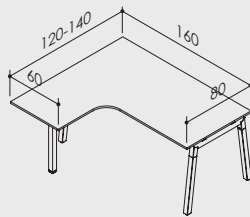

S91A SX / S91W SX

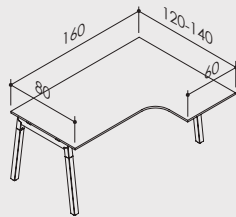

S90A DX / S90W DX

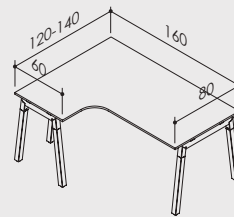

S90A SX / S90W SX

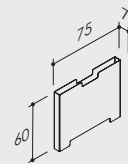

BENCH GAMBE "A" E "W" / BUREAUX BENCH PIEDS EN "A" ET EN "W" / "A" AND "W" LEG BENCH / "A" Y "W" PATA BENCH

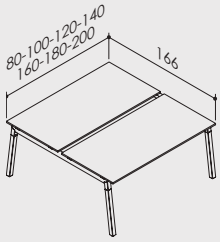

S60A / S60W

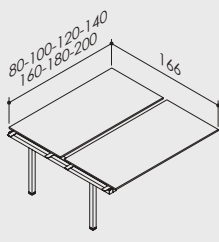

S65 / S65W

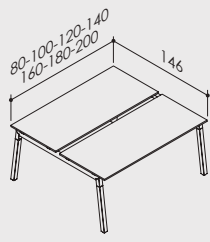

S61A / S61W

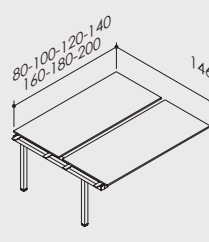

S66 / S66W

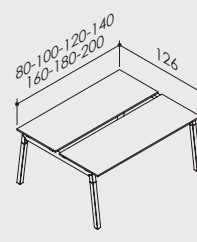

S50A / S50W

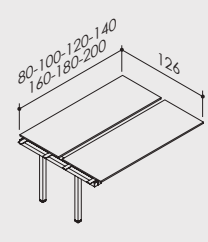

S55 / S55W

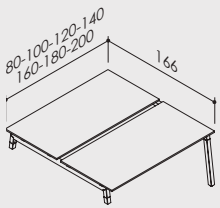

S60AM / S60WM

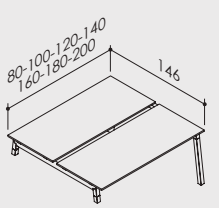

S61AM / S61WM

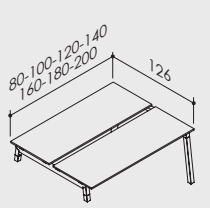

S50AM / S50WM

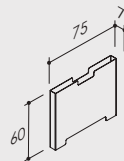

A17

TAVOLI RIUNIONE GAMBE "A" E "W" / TABLES DE RÉUNION PIEDS EN "A" ET EN "W" / "A" AND "W" LEG MEETING TABLES / MESAS DE REUNIONES PATA "A" Y "E"

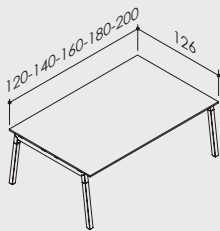

S40A / S40W

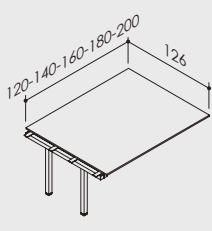

S41 / S41W

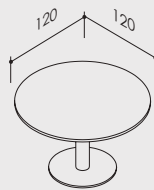

X11 120

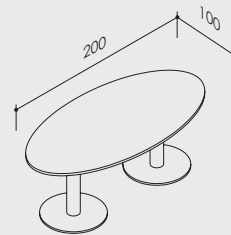

X12 200

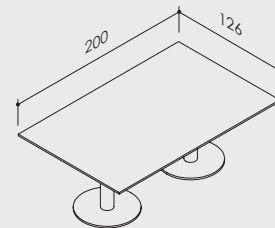

X10 200

TAVOLINI GAMBE "A" E "W" / TABLES BASSES PIEDS EN "A" ET EN "W" / "A" AND "W" LEG TABLES / MESAS PATA "A" Y "E"

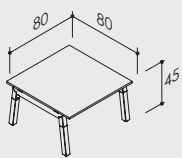

S45A / S45W

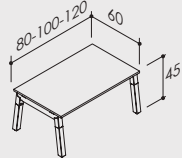

S46A / S46W

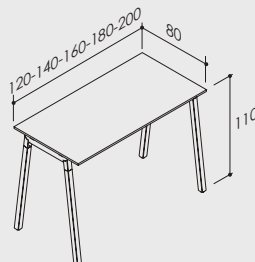

S10AH / S10WH

**Caratteristiche:**

- Gambe pannellate nobilitate disponibili in doppia versione di profondità.
- Gonna strutturale personalizzabile con 9 colorazioni.
- Piani in nobilitato disponibili in 9 finiture.
- Piani spessore 25 mm di serie.
- Nuovi allunghi su gamba pannellata.
- Ampia gamma di accessori disponibili in abbinamento.

Caractéristiques:

- Pieds panneaux anoblis disponibles en deux profondeurs différentes.
- Voile de fond structurel personnalisable en 9 coloris.
- Plateaux anoblis disponibles en 9 finitions.
- Plateaux de série de 25 mm d'épaisseur.
- Nouveaux retours sur pied panneau.
- Large gamme d'accessoires disponibles en combinaison.

Features:

- Melamine paneled legs available in double depth version.
- Customizable structural modesty panel with 9 colors.
- Melamine tops available in 9 finishes.
- 25 mm thick tops as standard.
- New extensions on paneled legs.
- Wide range of accessories available in combination.

K2



Características:

- Patas paneladas melamínicas disponibles en doble versión de profundidad.
- Faldón estructural personalizable con 9 colores.
- Encimera de melamina disponibles en 9 acabados.
- Encimera de 25 mm de espesor de serie.
- Nuevas extensiones en pierna panelada.
- Amplia gama de accesorios disponibles en emparejamiento.

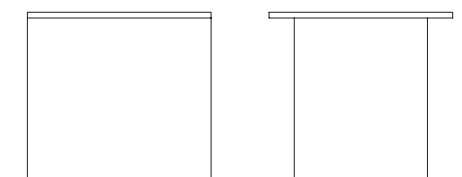

Gamba P.80 cm

Gamba P.58 cm



K2 01





K80

K2 può essere facilmente integrata con un'ampia gamma di accessori grazie alla trasversalità delle finiture che permette molteplici abbinamenti.

K2 peut être facilement intégré avec une large gamme d'accessoires grâce à la transversalité des finitions qui permet de nombreuses combinaisons.

K2 can be easily integrated with a wide range of accessories thanks to the transversality of the finishes that allows multiple combinations.

K2 se puede integrar fácilmente con una amplia gama de accesorios gracias a la transversalidad de los acabados que permite múltiples combinaciones.











Ogni modello presente a catalogo può essere personalizzata in dimensioni e finiture per soddisfare ogni richiesta.

Afin de satisfaire toutes demandes, les dimensions et les finitions de tous les modèles présents dans ce catalogue peuvent être personnalisées.

Each model in the catalog can be customized in dimensions and finishes to satisfy every request.

Cada modelo del catálogo se puede personalizar en dimensiones y acabados para satisfacer cualquier solicitud.



K2 03





K58

Una struttura perfetta per chi intende arredare i propri spazi con un prodotto essenziale, pratico e semplice.

C'est une structure parfaite pour qui a l'intention d'aménager ses propres espaces avec un produit essentiel, pratique et simple.

A perfect structure for those who intend to furnish their spaces with an essential, practical and simple product.

Una estructura perfecta para quienes pretenden amueblar sus espacios con un producto esencial, práctico y sencillo.



Finiture / Finitions / Finishings / Acabados

MELAMINICO LEGNO / MÉLAMINÉ DÉCOR BOIS / MELAMINE WOOD / MADERA MELAMINA



NC_Noce Canaletto



RS_Rovere Sbiancato



RG_Rovere Grigio



WE_Wengé



LA_Larice



OL_Olmo

MELAMINICO TINTA UNITA / MÉLAMINÉ TEINTE UNIE / PLAIN-COLORED MELAMINE / MELAMINA DE UN SOLO COLOR

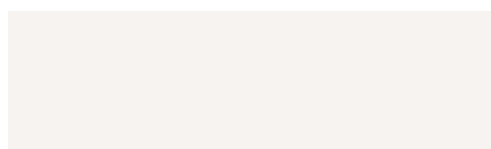

BI_Bianco



GR_Grigio



TO_Tortora

LACCATO LUCIDO E OPACO / LAQUÉ BRILLANT ET MAT / GLOSSY AND MATT LACQUER / LACADO



LAR_Arancio



LRS_Rosso



LBL_Blu



RAL a scelta / Couleurs RAL au choix
RAL to choose / RAL a elegir

TESSUTO / TISSU / TEXTURE / TEXTIL

TNR _Nero



TGR _Grigio



TBE _Beige



TBL _Blu



TCE _Celeste



TVE _Verde



TRS _Rosso



Tessuto a scelta / Tissu au choix
Texture to choose / Textil a elegir

Moduli / Modules / Modules / Modulos

SCRIVANIE / BUREAUX / DESKS / ESCRITORIOS

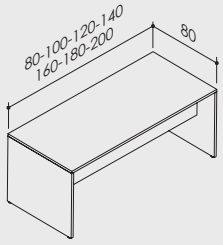

K80

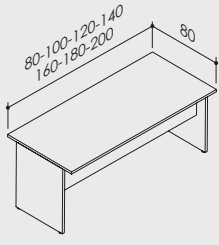

K58

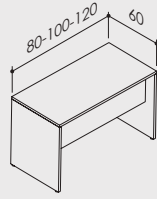

K30

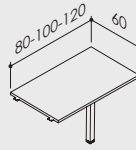

X20

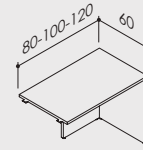

K20

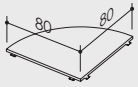

C50

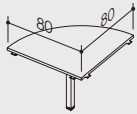

C51

TAVOLI RIUNIONE / TABLES DE RÉUNION / MEETING TABLES / MESAS DE REUNIONES

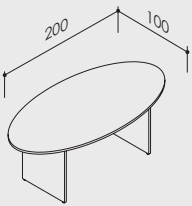

K40 240

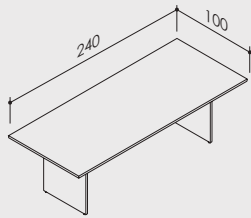

K40 200

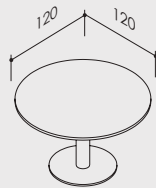

X11 120

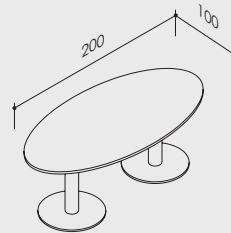

X12 200

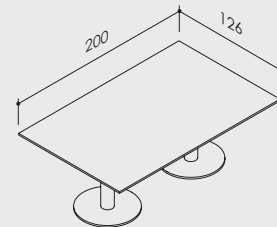

X10 200

**Caratteristiche:**

- Struttura con doppia soluzione di serie per gambe a "T" o "L".
- Strutture disponibili in 2 finiture.
- Travi fisse su scrivanie ad altezza fissa.
- Travi telescopiche su scrivanie ad altezza variabile.
- Strutture a controllo elettronico della regolazione in altezza disponibile in 3 modelli e 3 finiture.
- Piani in nobilitato disponibili in 9 finiture.
- Piani spessore 25 mm.

Caractéristiques:

- Structure avec deux solutions de série pour les pieds en « T » ou en « L ».
- Structures disponibles en 2 finitions.
- Poutres fixes sur les bureaux de hauteur fixe.
- Poutres télescopiques sur les bureaux de hauteur variable.
- Structures réglables en hauteur par contrôle électronique, disponibles en 3 modèles et 3 finitions.
- Plateaux anoblis disponibles en 9 finitions.
- Plateaux de 25 mm d'épaisseur

Features:

- Structure with double standard solution for "T" or "L" legs.
- Structures available in 2 finishes.
- Fixed beams on fixed height desks.
- Telescopic beams on variable height desks.
- Electronically controlled structures with height adjustment available in 3 models and 3 finishes.
- Melamine tops available in 9 finishes.
- 25 mm thick tops.

IorC



Características:

- Estructura con doble solución de estándar para patas con formas de "T" o "L".
- Estructuras disponibles en 2 acabados.
- Vigas fijas en escritorios de altura fija.
- Vigas telescópicas en escritorios de altura variable.
- Estructuras reguladoras con altura controlada electrónicamente disponible en 3 modelos y 3 acabados.
- Encimeras de melamina disponibles en 9 acabados.
- Encimeras de 25 mm de espesor.

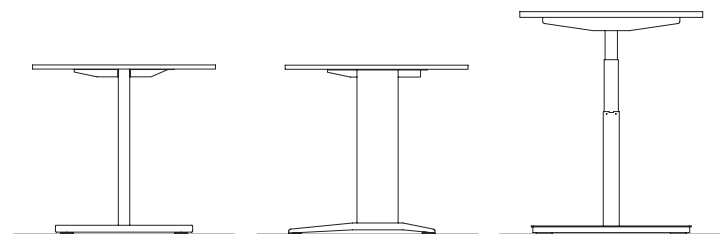

Gamba I

Gamba C

Gamba
REGOLABILE

RED Exclusive Design:

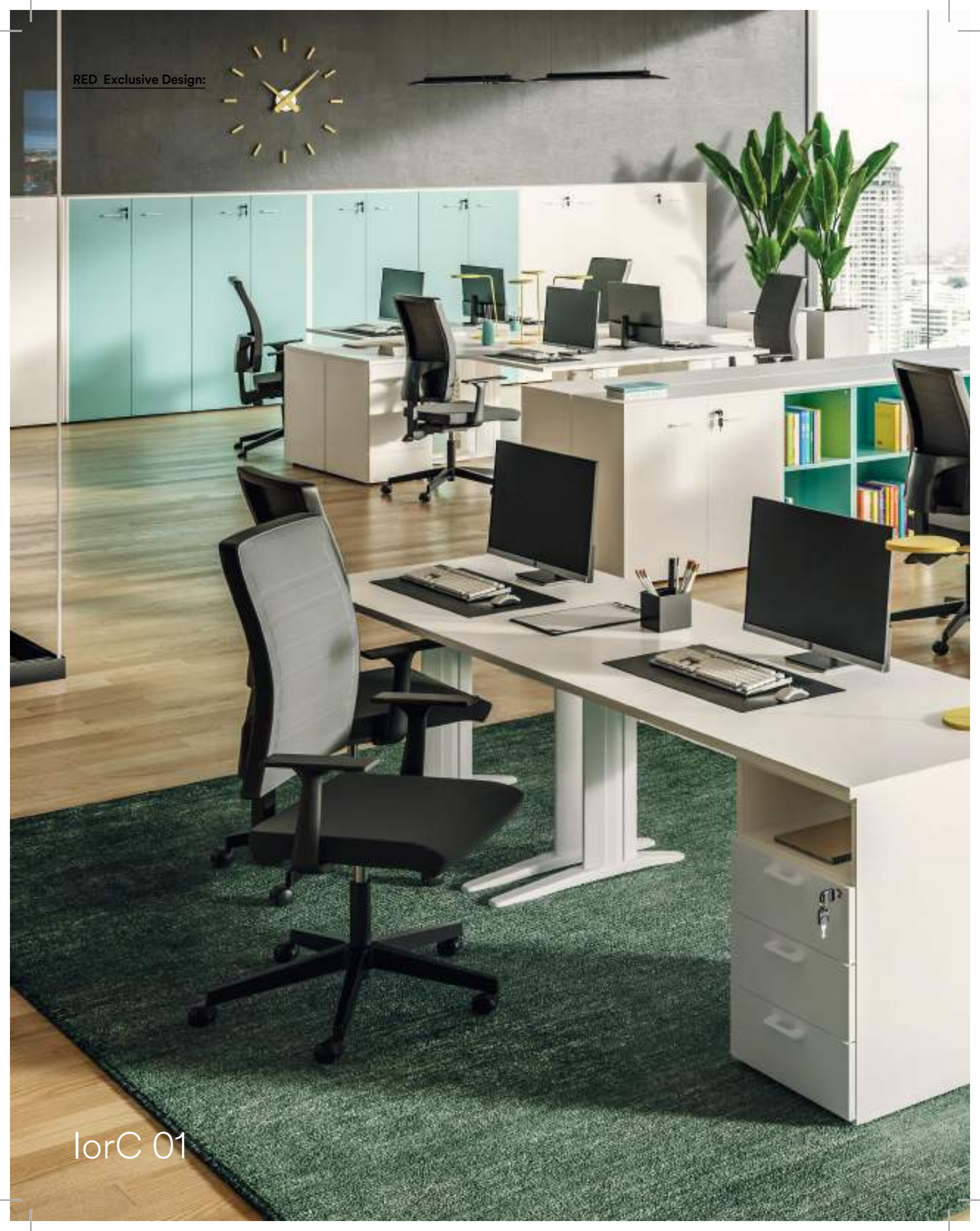

IorC 01





Gamba C

lorC è un sistema ufficio versatile e polifunzionale che si adatta perfettamente ad ambienti operativi.

lorC est un système pour bureau polyvalent et polyfonctionnel qui s'adapte parfaitement aux espaces opératifs.

lorC is a versatile and multifunctional office system that can be adapted perfectly to operational environments.

lorC es un sistema de oficina versátil y multifuncional que se adapta perfectamente a los entornos operativos.





IorC 02





Gamba I

Scrivanie operative angolari con cassettiere portanti. È possibile personalizzare le finiture di struttura, cassetti e maniglie.

Pour les bureaux opératifs d'angle avec des caissons porteurs, il est possible de personnaliser les finitions de la structure, des tiroirs et des poignées.

Corner operative desks with load-bearing drawer units. It is possible to customize the finishes of the structure, the drawers and the handles.

Escritorios operativos esquineros con cajoneras portantes. Es posible personalizar los acabados de la estructura, los cajones y los tiradores.











Struttura Regolabile / Structure Réglable / Adjustable structure / Estructura Ajustable



La struttura regolabile in altezza permette di alternare il lavoro in piedi o seduti, mantenendo sempre una posizione ergonomicamente corretta.

La structure réglable en hauteur permet d'alterner le travail debout et assis, en maintenant toujours une posture correcte.

The height-adjustable structure allows you to alternate between a standing and a sitting work, always maintaining an ergonomically correct position.

La estructura ajustable en altura permite alternar el trabajo de pie o sentado, manteniendo siempre una posición ergonómicamente correcta.

Finiture / Finitions / Finishings / Acabados

STRUTTURA / STRUCTURE / FRAME / ESTRUCTURA



AL_Alluminio

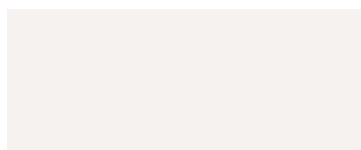

BI_Bianco



NR_Nero

MELAMINICO LEGNO / MÉLAMINÉ DÉCOR BOIS / MELAMINE WOOD / MADERA MELAMINA



NC_Noce Canaletto



RS_Rovere Sbiancato



RG_Rovere Grigio



WE_Wengé



LA_Larice



OL_Olmo

MELAMINICO TINTA UNITA / MÉLAMINÉ TEINTE UNIE / PLAIN-COLORED MELAMINE / MELAMINA DE UN SOLO COLOR

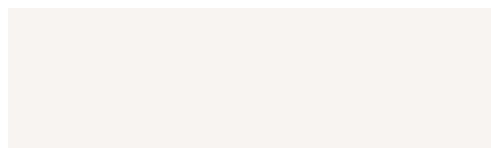

BI_Bianco



GR_Grigio



TO_Tortora

LACCATO LUCIDO E OPACO / LAQUÉ BRILLANT ET MAT / GLOSSY AND MATT LACQUER / LACADO



LAR_Arancio



LRS_Rosso



LBL_Blu



RAL a scelta / Couleurs RAL au choix
RAL to choose / RAL a elegir

TESSUTO / TISSU / TEXTURE / TEXTIL

TNR _Nero



TGR _Grigio



TBE _Beige



TBL _Blu



TCE _Celeste



TVE _Verde



TRS _Rosso



Tessuto a scelta / Tissu au choix
Texture to choose / Textil a elegir

Moduli / Modules / Modules / Modulos

SCRIVANIE GAMBA "I" / BUREAUX PIEDS EN "I" / "I" LEG DESKS / ESCRITORIOS PATA "I"

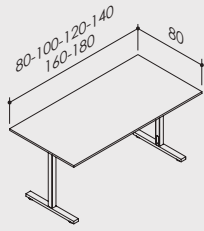

I10

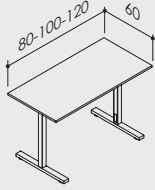

I30

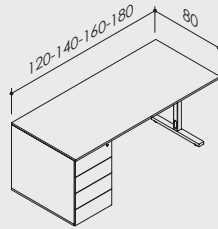

I40

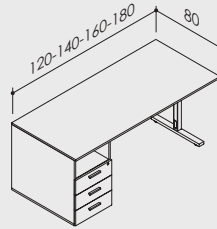

I45

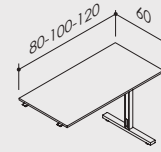

I20

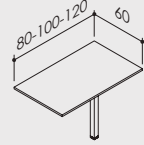

X20

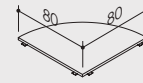

C50

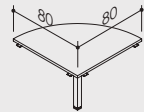

C51

SCRIVANIE COMPATTE GAMBA "I" / BUREAUX COMPACTS PIEDS EN "I" / "I" LEG COMPACT DESKS / ESCRITORIOS COMPACTOS PATA "I"

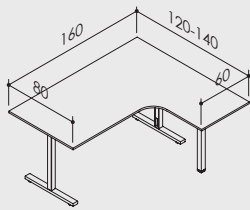

I90 DX

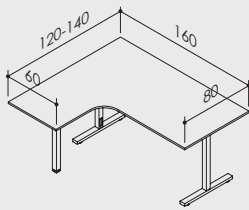

I90 SX

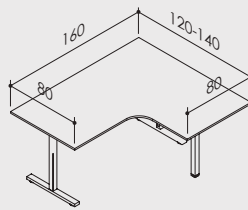

I91 DX

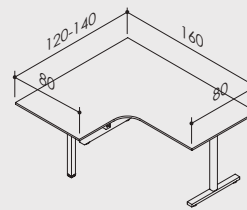

I91 SX

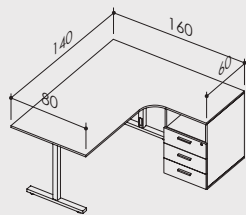

I94 140 DX

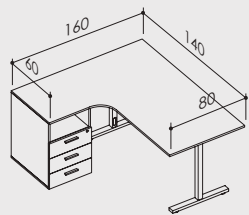

I94 140 SX

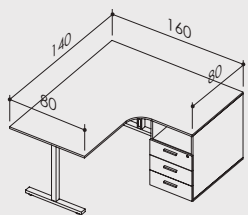

I95 140 DX

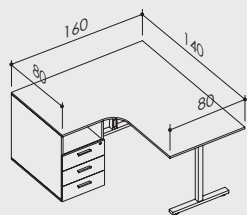

I95 140 SX

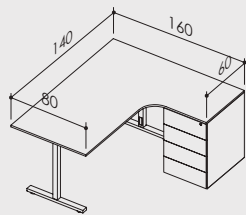

I92 140 DX

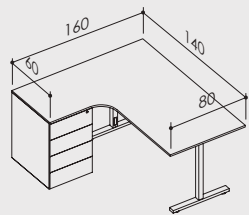

I92 140 SX

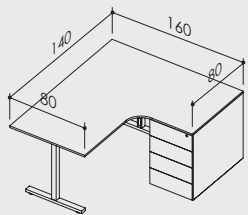

I93 140 DX

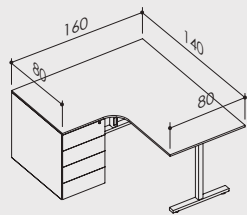

I93 140 SX

SCRIVANIE REGOLABILI / BUREAUX RÉGLABLES / ADJUSTABLE DESKS / ESCRITORIOS REGULABLES

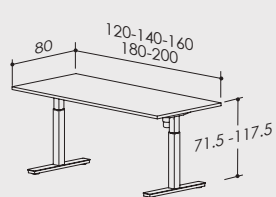

H10R

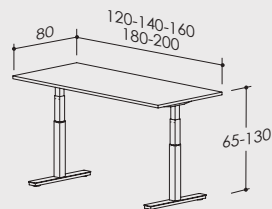

C10R

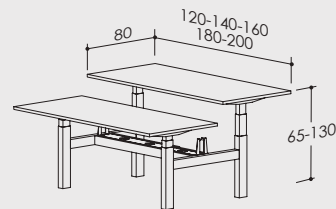

D10R

SCRIVANIE GAMBA "C" / BUREAUX PIEDS EN "C" / "C" LEG DESKS / ESCRITORIOS PATA "C"

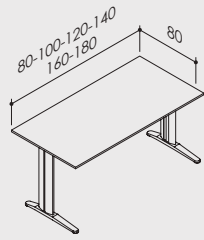

C10

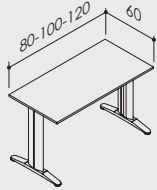

C30

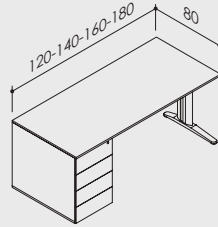

C40

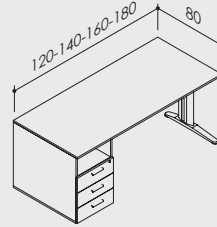

C45

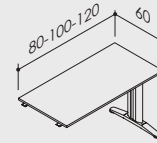

C20

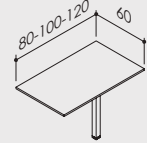

X20

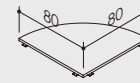

C50

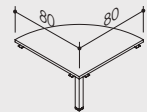

C51

SCRIVANIE COMPATTE GAMBA "C" / BUREAUX COMPACTS PIEDS EN "C" / "C" LEG COMPACT DESKS / ESCRITORIOS COMPACTOS PATA "C"

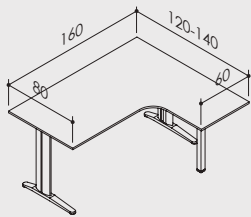

C90 DX

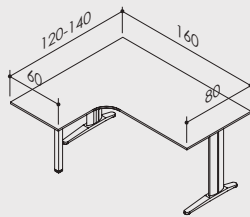

C90 SX

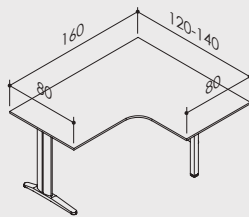

C91 DX

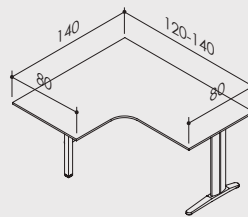

C91 SX

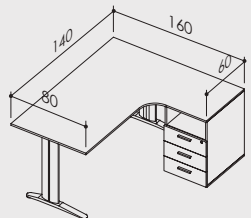

C94 140 DX

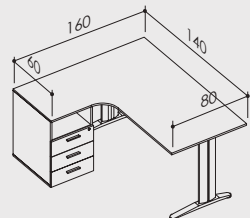

C94 140 SX

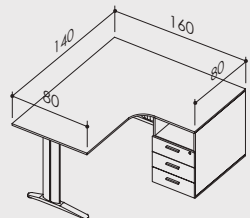

C95 140 DX

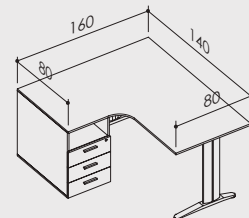

C95 140 SX

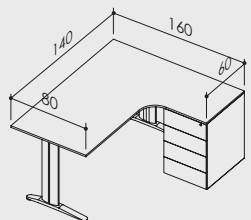

C92 140 DX

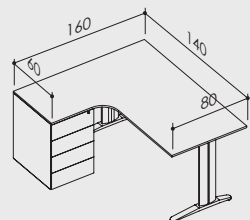

C92 140 SX

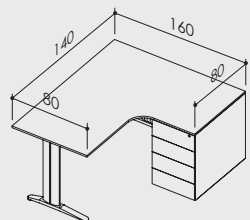

C93 140 DX

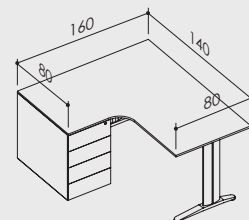

C93 140 SX

TAVOLI RIUNIONE / TABLES DE RÉUNION / MEETING TABLES / MESAS DE REUNIONES

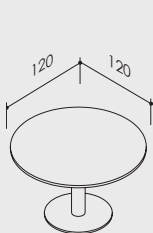

X11 120

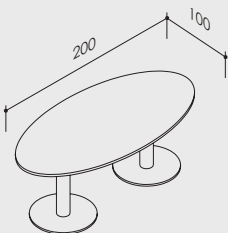

X12 200

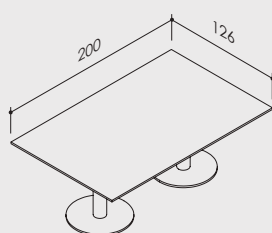

X10 200



Caratteristiche:

- Composizioni di serie in 9 finiture.
- Soluzioni lineari o curve.
- Modularità infinita.
- Top personalizzabili.
- Aggancio universale per i piani di lavoro.
- Personalizzazioni su richiesta.

Caractéristiques:

- Compositions de série en 9 finitions.
- Solutions linéaires ou courbes.
- Modulable à l'infini
- Plateau personnalisable
- Fixation universelle pour les plans de travail
- Personnalisation sur demande

Features:

- Standard compositions in 9 finishes.
- Linear or curved solutions.
- Infinite modularity.
- Customizable tops.
- Universal coupling for worktops.
- Customizations on request.

MAGIC

Características:

- Composiciones estándar en 9 acabados.
- Soluciones lineales o curvas.
- Modularidad infinita.
- Encimeras personalizables.
- Gancho universal para encimeras.
- Personalizaciones bajo pedido.



MAGIC 01

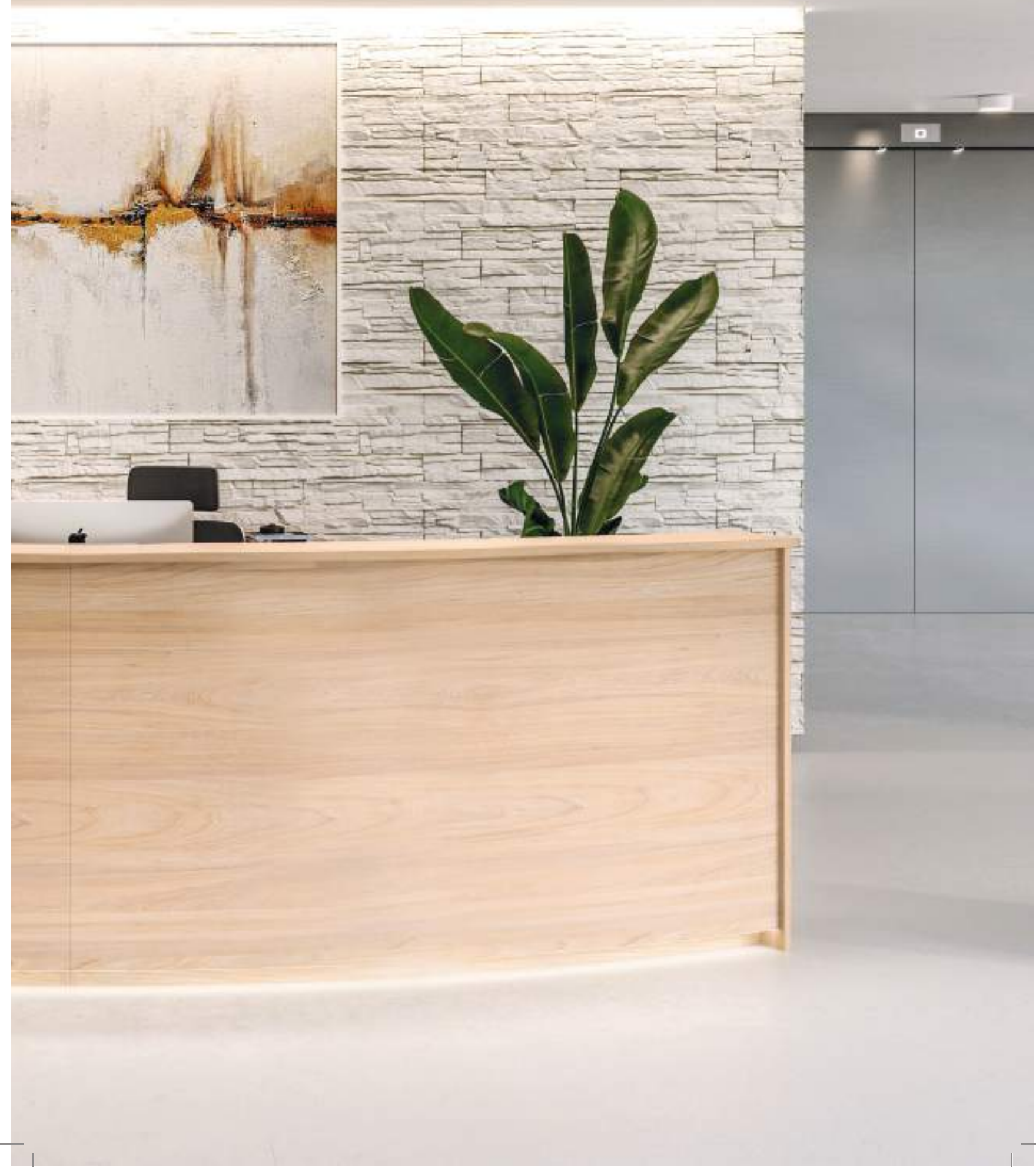





La configurazione curva, sinuosa ed elegante, si completa con l'illuminazione led.

La configuration courbe, sinueuse et élégante est complétée par un éclairage à LED.

The curved, sinuous and elegant configuration is completed with LED lighting.

La configuración curva, sinuosa y elegante se completa con una iluminación LED.



MAGIC 02





MAGIC 03





Semplicità compositiva e stile minimale rendono Magic adatto ad ogni contesto.

La simplicité de la composition et le style minimaliste font de Magic un modèle adapté à tout contexte.

Compositional simplicity and minimal style make Magic suitable for any environment.

La simplicidad compositiva y el estilo minimalista hacen que Magic sea adecuado para cualquier contexto.









MAGIC 05









MAGIC 06









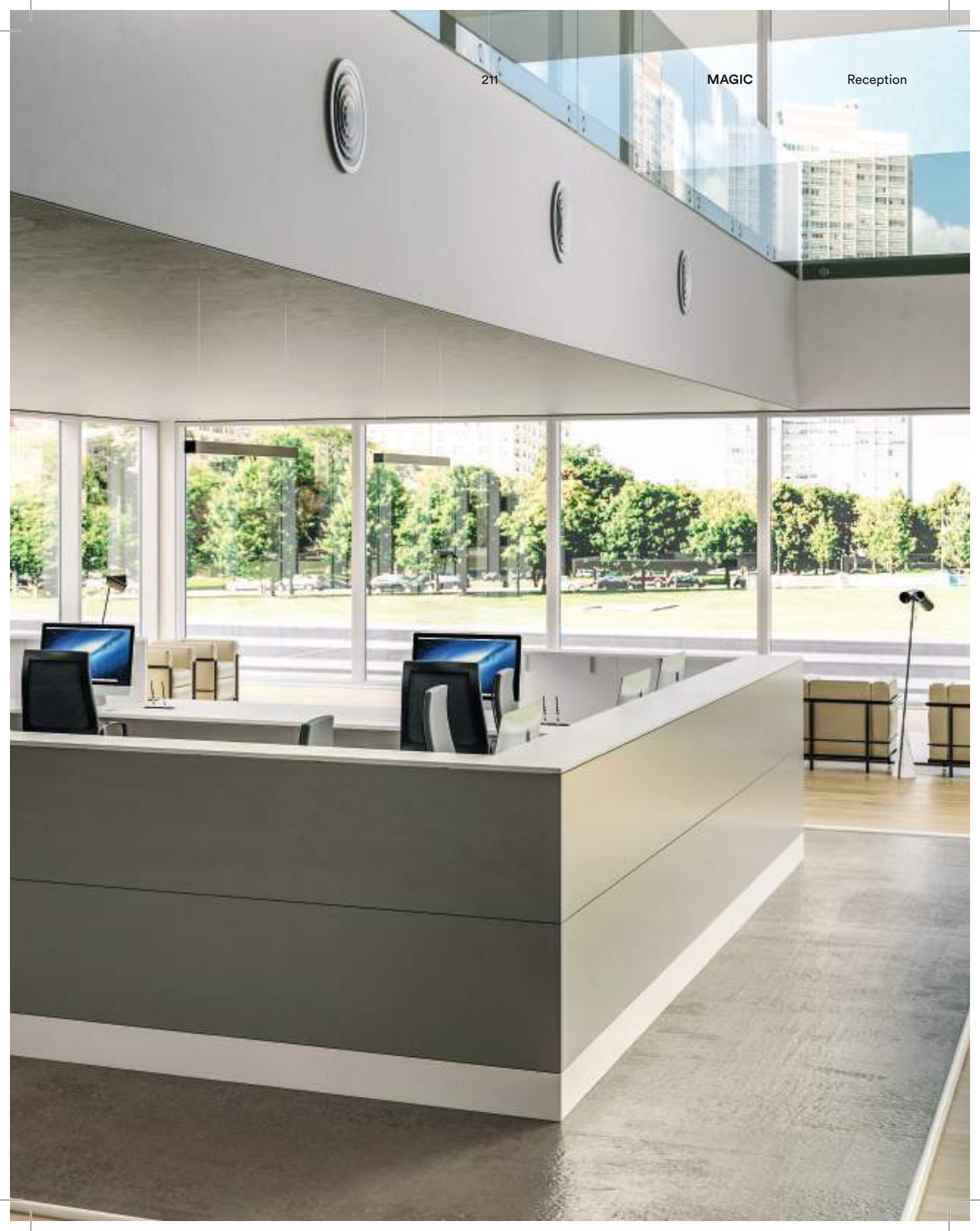



Il bancone di ricezione è luogo di molteplici attività, è essenziale creare uno spazio funzionale e confortevole per la risorsa che vi lavora.

Le comptoir d'accueil est le lieu de multiples activités, il est donc essentiel de créer un espace fonctionnel et confortable pour qui y travaille.

The reception desk is a place for multiple activities, it is essential to create a functional and comfortable space for the resource who works there.

El mostrador de recepción es un lugar para múltiples actividades, es fundamental crear un espacio funcional y cómodo para el recurso que allí trabaja.















Magic permette di generare infinite composizioni con forme e dimensioni differenti, dalle più compatte alle più ampie per ospitare più operatori.

Magic permet de créer une infinité de compositions aux formes et dimensions différentes, des plus compacts aux plus larges offrant plusieurs postes de travail.

Magic allows you to create infinite compositions with different shapes and sizes, from the most compact to the largest to accommodate more workers.

Magic te permite crear infinitas composiciones con diferentes formas y tamaños, desde las más compactas hasta las más grandes para acomodar a más trabajadores.

Finiture / Finitions / Finishings / Acabados

COMPONENTI / COMPOSANTS / COMPONENTS / COMPONENTES



AL_Alluminio

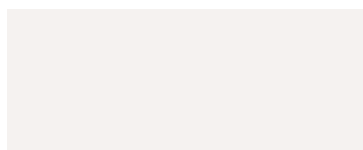

BI_Bianco



NR_Nero

MELAMINICO LEGNO / MÉLAMINÉ DÉCOR BOIS / MELAMINE WOOD / MADERA MELAMINA



NC_Noce Canaletto



RS_Rovere Sbiancato



RG_Rovere Grigio



WE_Wengé



LA_Larice



OL_Olmo

MELAMINICO TINTA UNITA / MÉLAMINÉ TEINTE UNIE / PLAIN-COLORED MELAMINE / MELAMINA DE UN SOLO COLOR

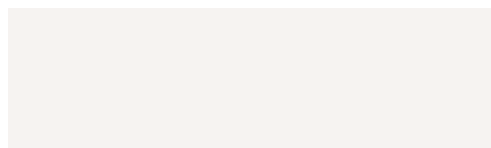

BI_Bianco



GR_Grigio



TO_Tortora

LACCATO LUCIDO E OPACO / LAQUÉ BRILLANT ET MAT / GLOSSY AND MATT LACQUER / LACADO



LAR_Arancio



LRS_Rosso



LBL_Blu



RAL a scelta / Couleurs RAL au choix
RAL to choose / RAL a elegir

Moduli / Modules / Modules / Modulos

MAGIC COMPONIBILE / MAGIC COMPONIBLE / MAGIC COMPONIBLE / MAGIC MODULAR

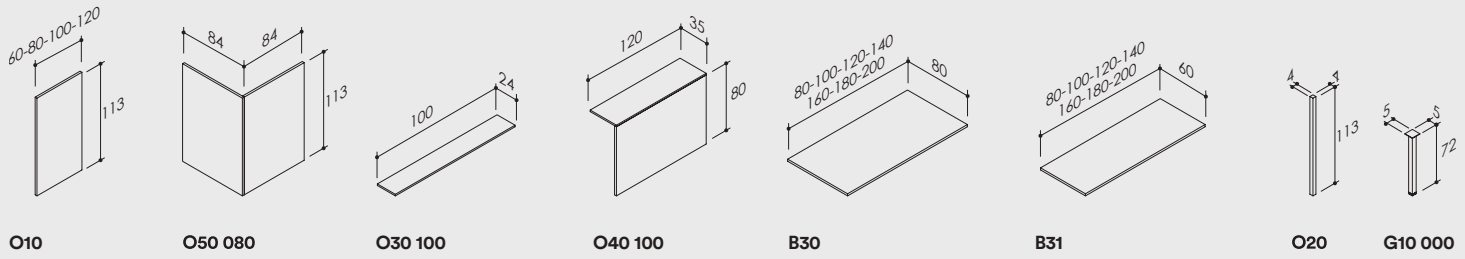

MAGIC CURVO / MAGIC COURBE / MAGIC CURVED / MAGIC CURVA

MODULO CURVO CENTRALE

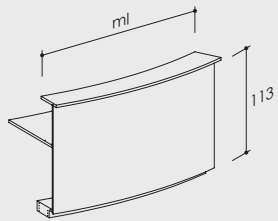

O60

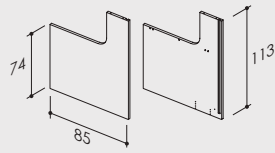

O61 085

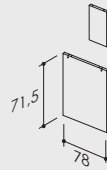

O62 078

MODULO CORTESIA

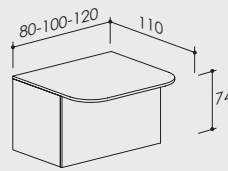

O65

MAGIC LINEARI / MAGIC LINÉAIRE / MAGIC LINEAR / MAGIC LINEAL

MODULO LINEARE H74 cm CON 1 INSERTO + ZOCCOLO

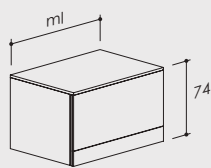

O70

MODULO LINEARE H110 cm CON 2 INSERTI + ZOCCOLO

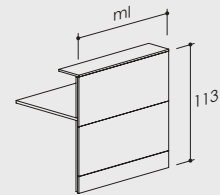

O71

MODULO LINEARE H110 cm CON 3 INSERTI

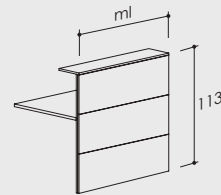

O73

COPPIE FIANCHI PER MODULI H110 cm

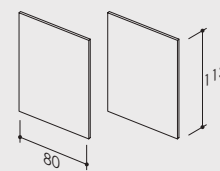

DRITTI
072 080

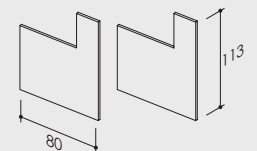

SAGOMATI
074 080

MODULO LINEARE SPESSORE 36/38mm IN NOBILITATO H74 cm

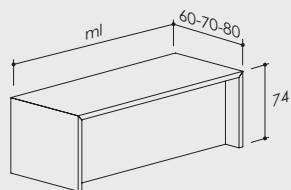

O80

TOP A SBALZO PER MODULO 080

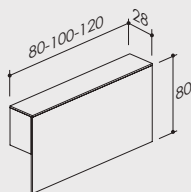

O81

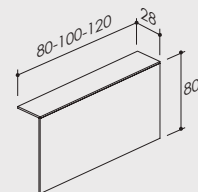

O82



Caratteristiche:

- Casse ed ante disponibili in 9 finiture di serie.
- Schienale spessore 18 mm o in alternativa in 6 mm bianco.
- Ripiani spessore 25 mm o in acciaio.
- Ante personalizzabili in finiture laccate o in cristallo.
- Combinazioni di colori senza limiti.
- Personalizzazioni su richiesta.

Caractéristiques:

- Corps et portes disponibles en 9 finitions de série.
- Panneau arrière de 18 mm d'épaisseur ou comme alternative de 6 mm en blanc.
- Tablettes de 25 mm d'épaisseur ou en acier .
- Portes personnalisables en finitions laquées ou en cristal.
- Combinaisons de couleurs sans limites.
- Personnalisation sur demande.

Features:

- Cases and doors available in 9 standard finishes.
- Back 18 mm thick or alternatively in 6 mm white.
- Shelves 25 mm thick or in steel.
- Customizable doors in lacquered or crystal finishes.
- Unlimited color combinations.
- Customizations on request .

ARMADI

**Caratteristiche:**

- Armarios y puertas disponibles en 9 acabados estándar.
- Dorso de 18 mm de espesor o alternativamente en blanco de 6 mm.
- Estantes de 25 mm de espesor o en acero.
- Puertas personalizables en acabados lacados o en cristal.
- Combinaciones de colores ilimitadas.
- Personalizaciones a pedido.



Le strutture a giorno si integrano perfettamente con tutta la gamma di prodotti RED, grazie alla trasversalità delle finiture ed alla possibilità di personalizzare le tinte selezionandole dalla mazzetta RAL.

Les structures ouvertes s'intègrent parfaitement avec toute la gamme de produits RED grâce à la transversalité des finitions et à la possibilité de personnaliser les coloris en les choisissant dans le nuancier RAL.

The open structures integrate perfectly with the entire range of RED products, thanks to the transversality of the finishes and the possibility of customizing the colors by selecting them from the RAL fan decks.

Las estructuras se integran perfectamente con toda la gama de productos RED, gracias a la transversalidad de los acabados y la posibilidad de personalizar los colores seleccionándolos de la muestra RAL.



Le strutture a giorno in melaminico, fruibili ad uso libreria, possono essere completate con ante in melaminico tinta unita, melaminico legno o ante laccate. In quest'ultimo caso è possibile selezionare la tinta RAL preferita, per personalizzare al meglio l'ambiente di lavoro.

Les structures ouvertes en mélaminé, utilisables comme bibliothèque, peuvent être complétées par des portes en mélaminé décor uni, en mélaminé décor bois ou par des portes laquées. Dans ce dernier cas, il est possible de sélectionner la couleur RAL préférée afin de personnaliser au mieux l'espace de travail.

The open structures in melamine, for use as a bookcase, can be completed with doors in solid color melamine, wood melamine or lacquered doors. In the latter case, it is possible to select the preferred RAL color, to better customize the work environment.

Las estructuras abiertas en melamina, utilizables para uso librería, se pueden completar con puertas en melamina de color liso, melamina de madera o puertas lacadas. En este último caso, es posible seleccionar el color RAL preferido, para mejor personalizar el entorno de trabajo.





In alternativa all'alta in legno è possibile utilizzare l'anta in vetro, disponibile nelle finiture: trasparente, satinato e retrolaccato nei colori bianco e nero con telaio in alluminio.

À la place de la porte en bois, il est possible d'utiliser une porte vitrée, disponible dans les finitions suivantes : transparent, satiné et laqué blanc et noir avec le cadre en aluminium.

As an alternative to the wooden door, it is possible to use a glass door, available in the finishes: transparent, satin and back-lacquered in black and white with aluminum frame.

Como alternativa a la puerta de madera, es posible utilizar una puerta de vidrio, disponible en los acabados: transparente, satinado y lacado en blanco y negro con marco de aluminio.







Caratteristiche:

- Soluzioni in nobilitato disponibili in 9 finiture intercambiabili.
- Soluzioni metalliche in 3 finiture di serie.
- Soluzioni portanti in nobilitato con vano a giorno.
- Soluzioni soft closing disponibili per ogni modello.
- Personalizzabili su quantità.

Caractéristiques:

- Solutions en panneaux anoblis disponibles en 9 finitions interchangeables.
- Solutions en métal en 3 finitions de série.
- Solutions caissons porteurs ouverts en panneaux anoblis.
- Solutions avec mécanisme de fermeture amortie disponibles pour tous les modèles.
- Personnalisables à partir d'une certaine quantité.

Features:

- Melamine solutions available in 9 interchangeable finishes.
- Metallic solutions in 3 standard finishes.
- Supporting solutions in melamine with open compartment.
- Soft closing solutions available for each model
- Customizable on quantity.

CASSETTIERE

**Caratteristiche:**

- Soluciones de melamina disponibles en 9 acabados intercambiables.
- Soluciones metálicas en 3 acabados estándar.
- Soluciones portantes en melamina con compartimento abierto.
- Soluciones soft dosing disponibles para cada modelo.
- Personalizables en cantidad.

RED Exclusive Design:

232

Tutti i modelli forniti di cassetto classificatore sono sempre dotati di quinta ruota.

Tous les modèles munis d'un tiroir pour dossiers suspendus sont toujours équipés d'une cinquième roulette.

All models equipped with a filing drawer are always supplied with a fifth wheel.

Todos los modelos equipados con un cajón archivador siempre están provistos de una quinta rueda.



Cassettiere con struttura in metallo su ruote, caratterizzate da affidabili sistemi di scorrimento su guide a rulli o guide a sfera telescopiche.

Les caissons avec une structure en métal sur roulettes, se caractérisent par des systèmes de glissement fiables sur des coulisses à galets ou des glissières télescopiques à billes.

Drawer units with metal structure on wheels, characterized by reliable sliding systems on roller guides or telescopic ball guides.

Cajoneras con estructura metálica sobre ruedas, caracterizadas por fiables sistemas de deslizamiento sobre guías de rodillos o guías de bolas telescópicas.



Cassettiere portanti con struttura in metallo. Disponibili con frontali in metallo o in melaminico, nelle versioni con tre cassetti o con due cassetti e classificatore.

Les caissons porteurs avec une structure en métal sont disponibles avec la façade en métal ou en mélaminé, dans les versions avec trois tiroirs ou deux tiroirs plus un tiroir pour dossiers suspendus.

Load-bearing drawer units with metal structure. Available with metal or melamine fronts, in the versions with three drawers or with two drawers and a filing cabinet.

Cajoneras portantes con estructura metálica. Disponible con frentes de metal o melamina, en versiones con tres cajones o con dos cajones y archivador.





Cassettiere in melaminico su ruote, disponibili monocolori o bicolore. Tutti i modelli forniti di cassetto classificatore sono sempre dotati di quinta ruota.

Les caissons en mélaminé sur roulettes sont disponibles en teinte unie ou bicolore. Tous les modèles munis d'un tiroir pour dossiers suspendus sont toujours équipés d'une cinquième roulette.

Drawers units in melamine on wheels, available in monochrome or two-colour. All models equipped with a filing drawer are always supplied with a fifth wheel.

Cajones en melamina con ruedas, disponible en un color o en dos colores. Todos los modelos equipados con un cajón archivador siempre están provistos de una quinta rueda.





Indispensabili complementi dell'arredo di ogni spazio di lavoro, le cassettiere portanti in melaminico divengono parte integrante e strutturale della scrivania. Disponibili con cassetti dotati di serratura e vano a giorno.

Compléments indispensables à l'aménagement de tout espace de travail, les caissons porteurs en mélaminé deviennent une partie intégrante et structurelle des bureaux. Ils sont disponibles avec une case ouverte et des tiroirs munis de serrure.

Essential furnishing accessories for any workspace, the load-bearing drawer units in melamine become an integral and structural part of the desk. Available with drawers with lock and open compartment.

Complementos de decoración indispensables para cualquier espacio de trabajo, los cajones portantes de melamina se convierten en parte integrante y estructural del escritorio. Disponible con cajones con cerradura et compartimento abierto.





Caratteristiche:

- Su ruote solo nella versione con cassetiera e vano a giorno.
- 9 finiture nobilitate di serie per ogni soluzione.
- Laccatura personalizzabile per ogni componente.
- Posizioni interscambiabili in fase di montaggio per le versioni su piedini.
- Combinazioni di colori senza limiti.

Caractéristiques:

- Sur roulettes seulement dans la version caisson ouvert.
- 9 finitions de série en panneaux anoblis pour chaque solution.
- Laquage personnalisable pour tous les éléments.
- Positions interchangeables en phase de montage pour les versions sur pieds.
- Combinaisons de couleurs sans limites.

Features:

- On wheels only in the version with chest of drawers and open compartment.
- 9 standard melamine finishes for each solution.
- Customizable lacquering for each component.
- Interchangeable positions during the assembly for versions on feet.
- Unlimited color combinations.

MOBILI DI SERVIZIO

**Caratteristiche:**

- Sobre ruedas solo en la versión con cómoda y compartimento abierto.
- 9 acabados en melamina estándar para cada solución.
- Lacado personalizable para cada componente
- Posiciones intercambiables durante el montaje para versiones en los pantorrillas.
- Combinaciones de colores ilimitadas.



Mobile di servizio in melaminico, disponibile monocolore o bicolore su ruote con 3 cassetti dotati di serratura e vano giorno.

Le meuble de service en mélaminé est disponible en teinte unie ou bicolore, sur roulettes, avec 3 tiroirs munis de serrure et une case ouverte.

Service piece of furniture in melamine, available in monochrome or two-color on wheels with 3 drawers with lock and open compartment.

Mueble de servicio en melamina, disponible en un color o dos colores sobre ruedas con 3 cajones con cerradura y compartimento abierto.





Mobili di servizio in melaminico free-standing o per scrivania in appoggio. È possibile scegliere tra cassetiera a tre cassetti con serratura, anta con serratura e vano a giorno.

Pour les meubles de service en mélaminé indépendants ou porteurs intégrés à un bureau, il est possible de choisir entre un caisson avec trois tiroirs munis de serrure, une porte avec serrure et une case ouverte.

Service piece of furniture in free-standing melamine or for a floor standing desk version. You can choose among a drawer unit with three drawers with lock, a door with lock and an open compartment.

Mobiliario de servicio en melamina de pie libre o para escritorio en apoyo. Se puede elegir entre tres cajones con cerradura, puerta con cerradura y compartimento abierto.



Finiture / Finitions / Finishings / Acabados

MELAMINICO TINTA UNITA / MÉLAMINÉ TEINTE UNIE / PLAIN-COLORED MELAMINE / MELAMINA DE UN SOLO COLOR

Struttura, top e frontali / Structures, plateaux et façades / Structure, top and fronts / Estructura, encimera, delanteros

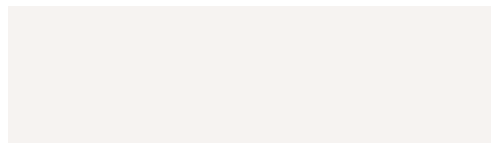

BI_Bianco



GR_Grigio



TO_Tortora

MELAMINICO LEGNO / MÉLAMINÉ DÉCOR BOIS / MELAMINE WOOD / MADERA MELAMINA

Struttura, top e frontali / Structures, plateaux et façades / Structure, top and fronts / Estructura, encimera, delanteros



NC_Noce Canaletto



RS_Rovere Sbiancato



RG_Rovere Grigio



WE_Wengé



LA_Larice



OL_Olmo

ESSENZE LEGNO / ESSENCES DE BOIS / WOOD FINISHES / ACABADOS EN MADERA

Struttura, top e frontali / Structures, plateaux et façades / Structure, top and fronts / Estructura, encimera, delanteros



NO_Noce



RLB_Rovere Laccato Bianco



RDG_Rovere Grigio



WDE_Wengé



RLN_Rovere Laccato Naturale

VETRI / VERRES / GLASS / VIDRIO

Ante / Portes / Doors / Puertas

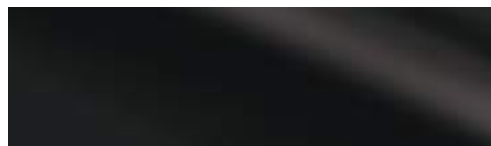
**VTR**_Trasparente**VTS**_Satinato**VNR**_Vetro Nero**VBI**_Vetro Bianco

RAL a scelta / Couleurs RAL au choix
RAL to choose / RAL a elegir

VSP_Vetro colore a scelta**LACCATO LUCIDO E OPACO** / LAQUÉ BRILLANT ET MAT / GLOSSY AND MATT LACQUER / LACADO**LAR**_Arancio**LRS**_Rosso**LBL**_Blu

RAL a scelta / Couleurs RAL au choix
RAL to choose / RAL a elegir

Moduli / Modules / Modules / Modulos

STRUTTURE ARMADI / STRUCTURES D'ARMOIRES / CABINETS STRUCTURES / ESTRUCTURA ARMARIOS

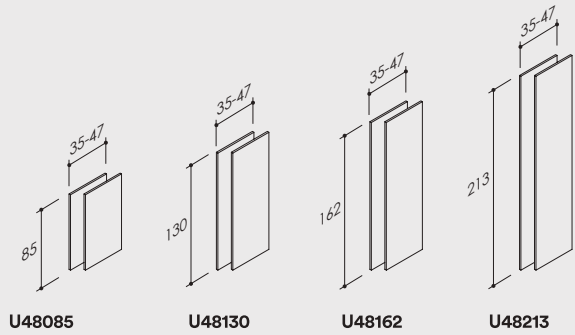
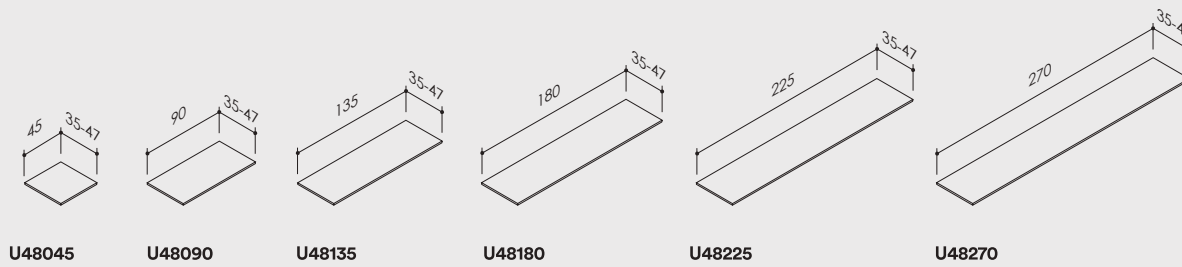
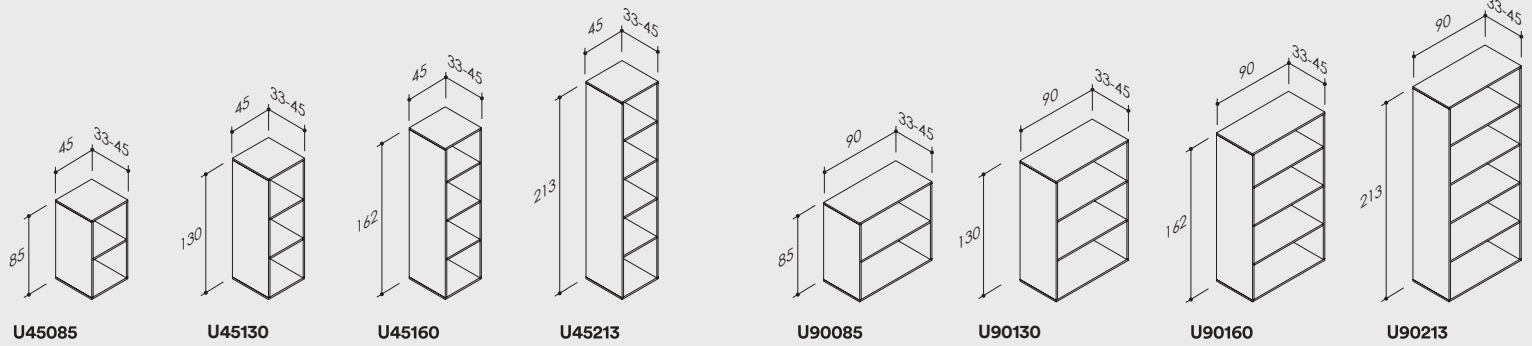

ANTE E SCHEDARI ARMADI / PORTES ET CLASSEURS POUR ARMOIRES / DOORS AND FILING CABINETS / PUERTAS Y ARCHIVADORES

ANTE IN LEGNO
PORTES EN BOIS
WOOD DOORS
PUERTA EN MADERA

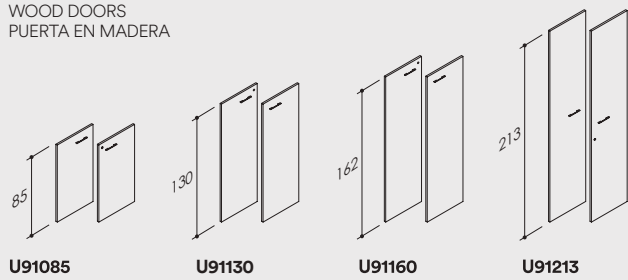

VERRO SATINATO/TRASPARENTE
VERRE SATINÉ/TRANSPARENT
TRANSPARENT/SATIN GLASS
VIDRIO ESMERILADO/TRANSPARENTE



ANTE IN VETRO RETROLACCATO (TELAIO)
PORTE EN VERRE LAQUÉ (CADRE)
BACK-LACQUERED GLASS DOORS (FRAME)
PUERTA EN VIDRIO RETRO-LAQUEADO (MARCO)

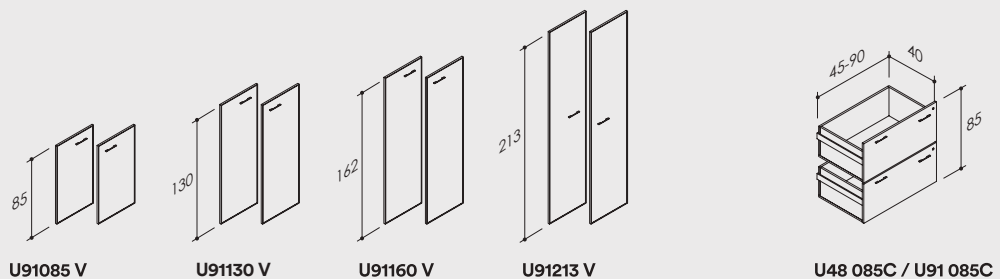

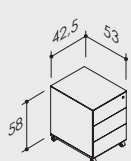
CASSETTIERE METALLO / CAISSONS EN MÉTAL / METAL DRAWER UNITS / CAJONERAS EN METAL

V 011

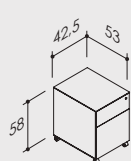

V 012

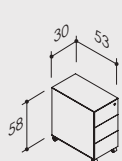

V 300

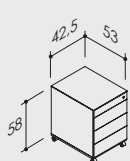

V 015

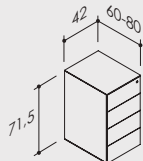

V 013

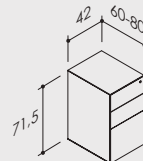

V 014

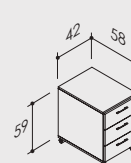
CASSETTIERE IN LEGNO / CAISSONS EN BOIS / WOOD DRAWER UNITS / CAJONERAS EN MADERA

V 001 / V 003

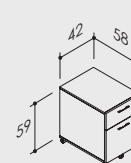

V 004

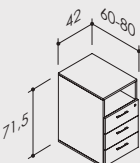

V 002

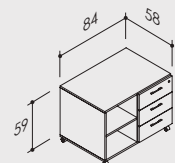
MOBILI DI SERVIZIO / MEUBLES DE SERVICE / SERVICE FURNITURE / MOBILIARIO DE SERVICIO

V 021

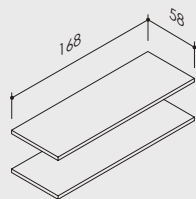
**ELEMENTI PER COMPORRE MOBILI DI SERVIZIO / ÉLÉMENTS POUR COMPOSER DES MEUBLES DE SERVICE
ELEMENTS TO MAKE SERVICE FURNITURE / ELEMENTOS PARA COMPOSER MOBILIARIO DE SERVICIO**

W60 000

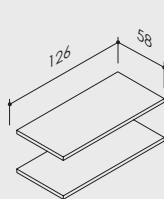

W60 003

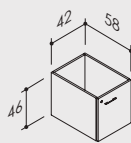

W60 020

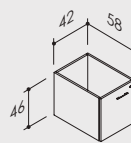

W60 030

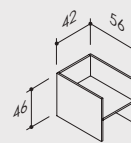

W60 040

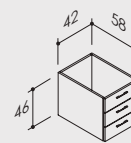

W60 001 / W60 002



Produzione Metallica:

C.da Rotondo, 10 - 62029 - Tolentino (MC)

Sede Logistica:

Via 1 Maggio, 3H - 62100 - Macerata (MC)

Produzione Legno:

Via Don Ezio Cingolani, 4 - 62010 - Montecassiano (MC)

Headquarters FR:

45 rue Delizy 93500 Pantin.

info@redexclusivedesign.com

pec@redexclusivedesign.com

P.IVA 04596500266

www.redexclusivedesign.com

Graphic Design: Studio Ortiga

Digital Image: Orygine

Stampa: Artelito S.p.a.

Rev. 11-2021

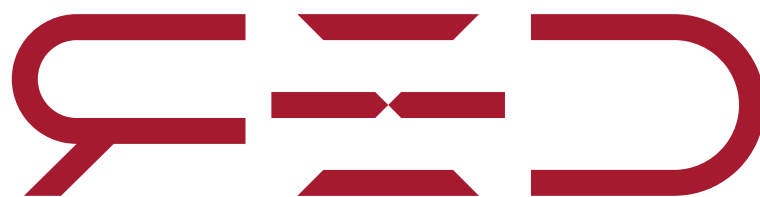

EXCLUSIVE DESIGN

Mail : contact@redexclusivedesign.fr
Numéro gratuit : 0805 691 217

www.redexclusivedesign.com

Rossini Exclusive Design R.E.D FRANCE – Agence SP Conseil
45 rue Delizy 93500 Pantin.